

Fassadenprofile

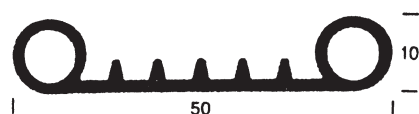

Fassadenprofile

aus Vollgummi bzw. Weich-PVC

GUK

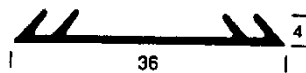

05 F 0119

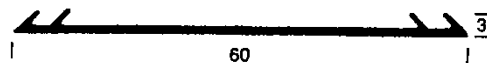

05 F 0120

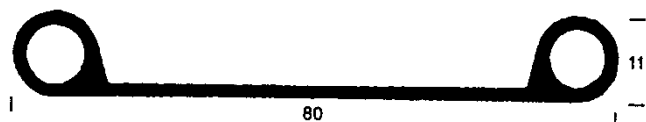

05 F 0220

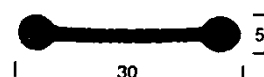

05 F 0287



05 F 0310



05 F 0330

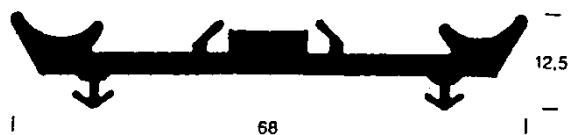

05 F 0336



05 F 0358

Fassadenprofile

aus Vollgummi bzw. Weich-PVC

GUK

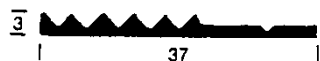

05 F 0361

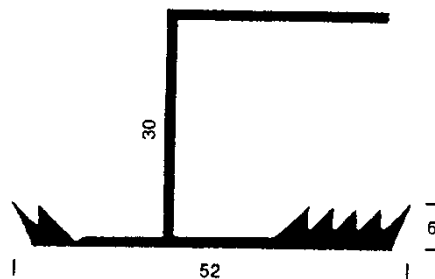

05 F 0399

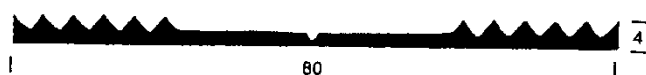

05 F 0400



05 F 0414



05 F 0417

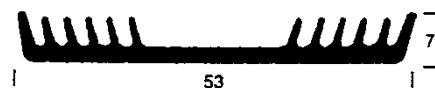

05 F 0419



05 F 0457

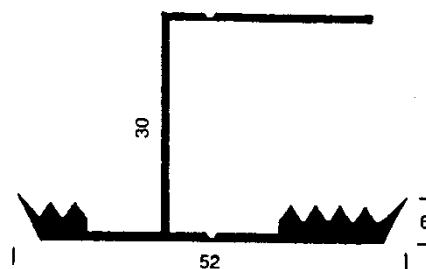

05 F 0459

Fassadenprofile

aus Vollgummi bzw. Weich-PVC

GUK

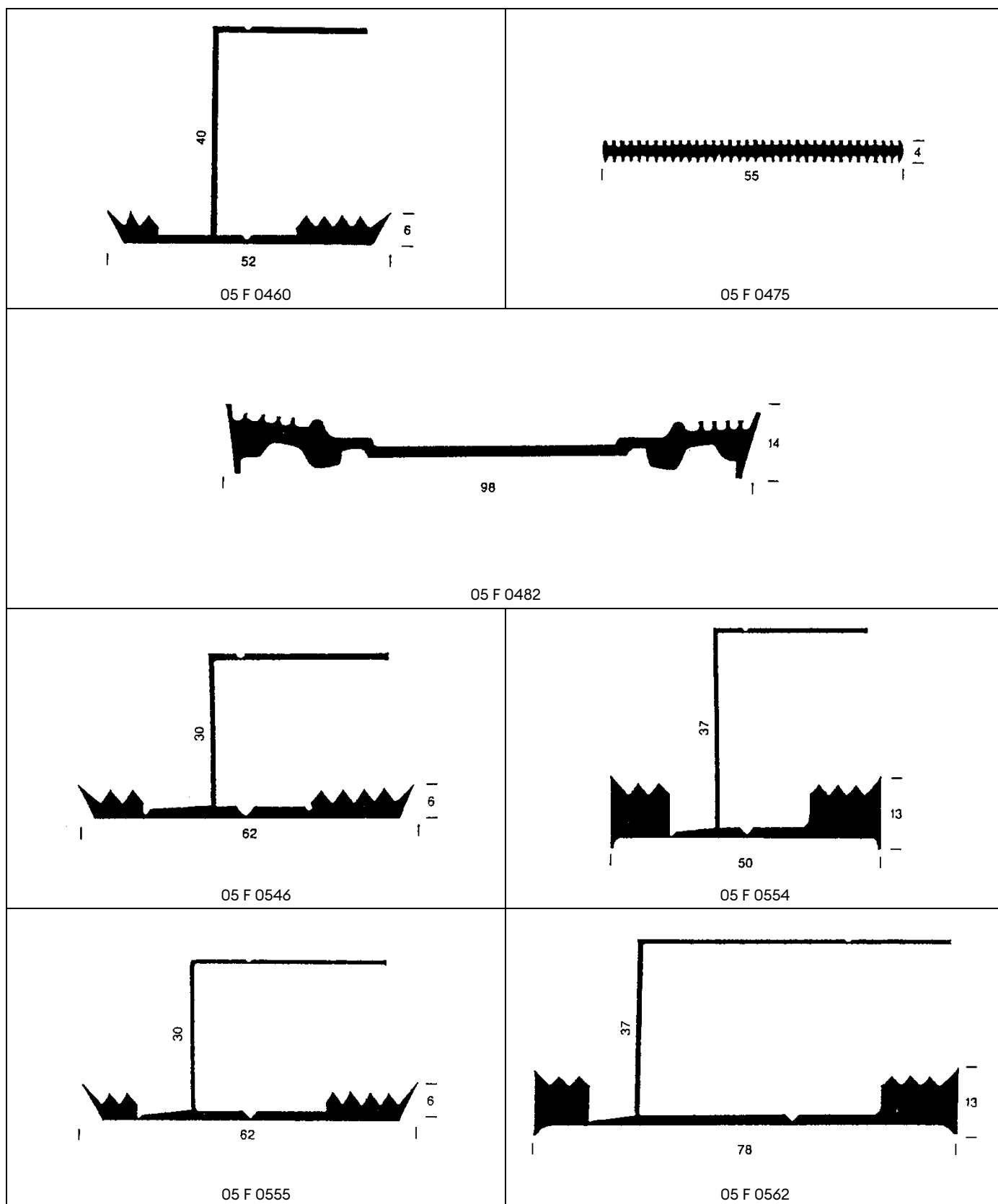

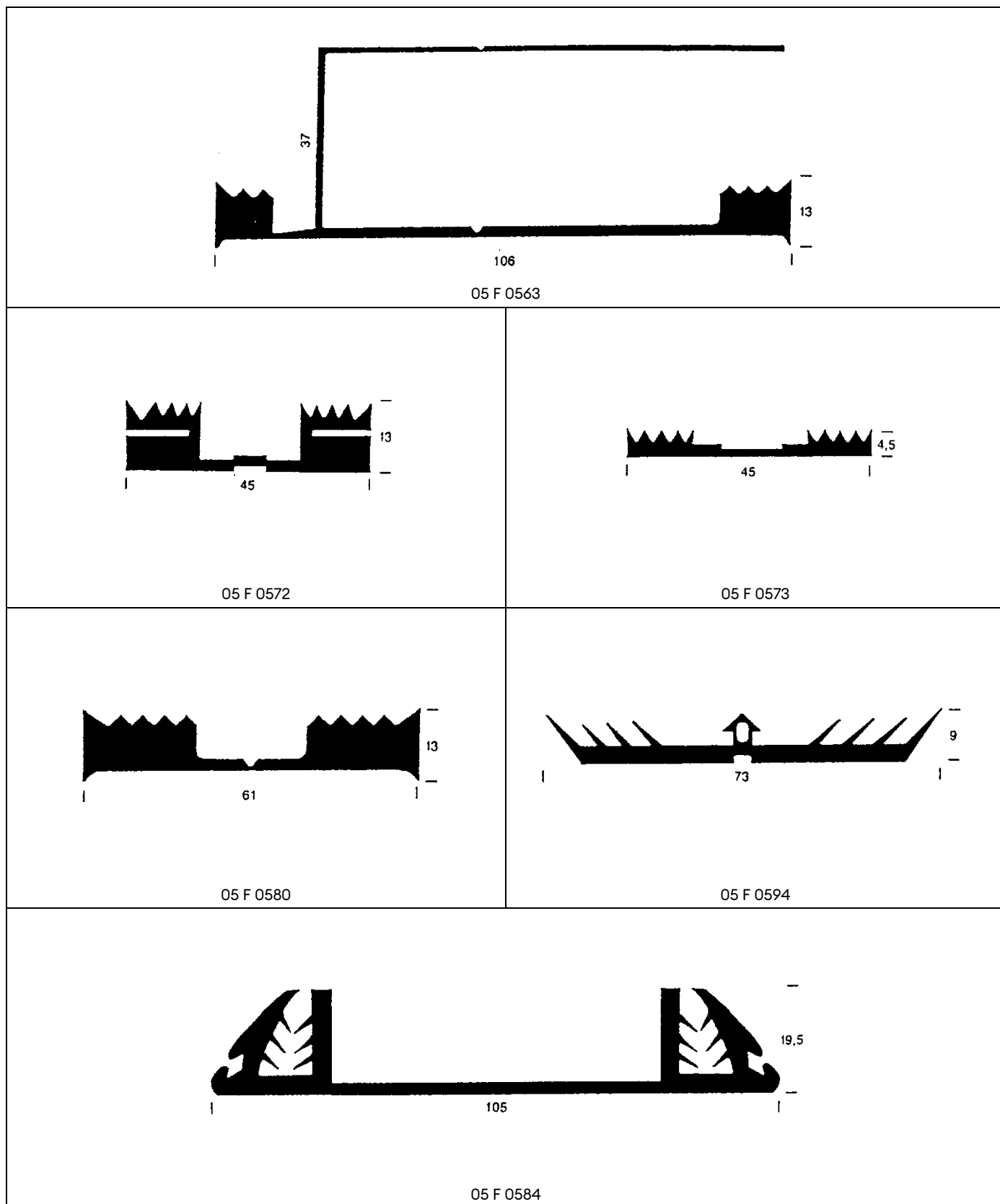

Fassadenprofile

aus Vollgummi bzw. Weich-PVC



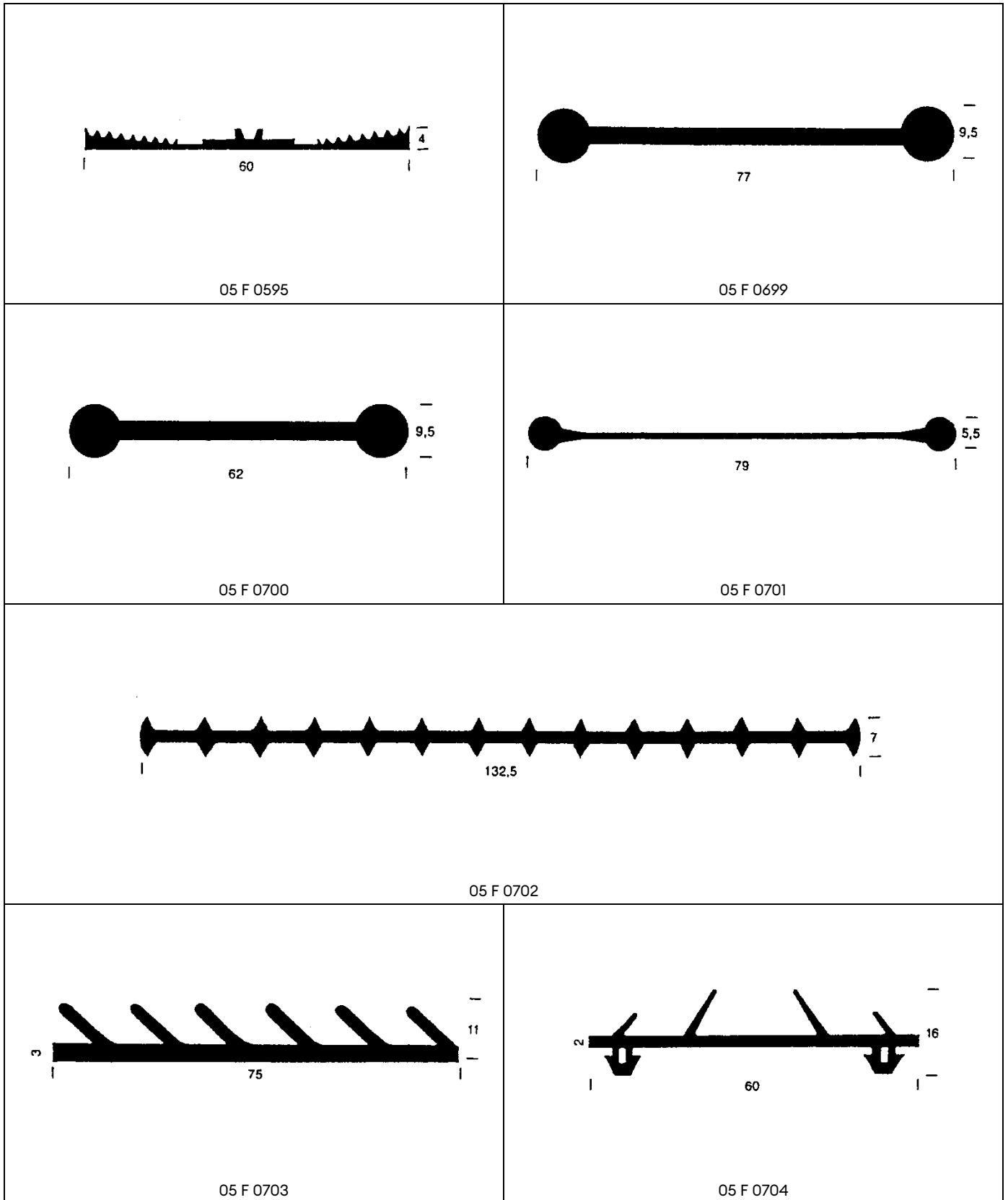

GUK

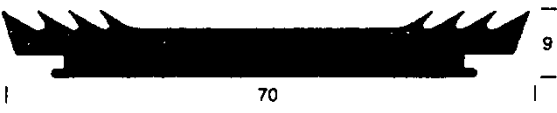

Fassadenprofile

aus Vollgummi bzw. Weich-PVC

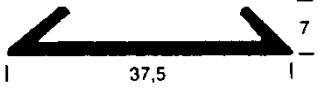

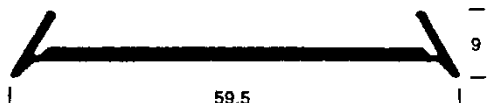
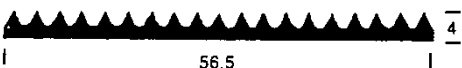
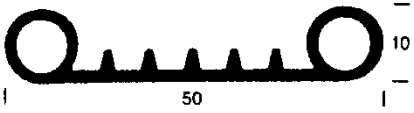

GUK

 <p>05 F 0705</p>	 <p>05 F 0706</p>	
 <p>05 F 0707</p>	 <p>05 F 0708</p>	 <p>05 F 0709</p>
 <p>05 F 0710</p>	 <p>05 F 0711</p>	
 <p>05 F 0712</p>	 <p>05 F 0713</p>	

Fassadenprofile

aus Vollgummi bzw. Weich-PVC

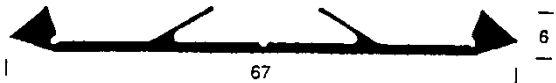
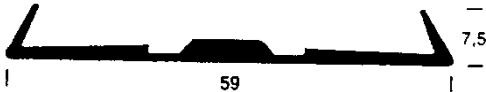
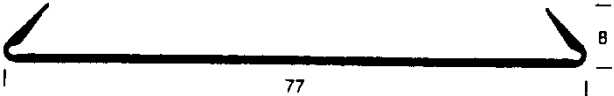
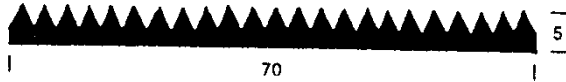
GUK

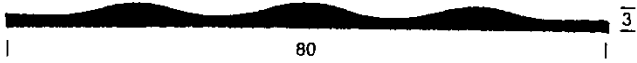
 <p>05 F 0714</p>	 <p>05 F 0715</p>
 <p>05 F 0716</p>	 <p>05 F 0717</p>
 <p>05 F 0718</p>	 <p>05 F 0719</p>
 <p>05 F 0720</p>	 <p>05 F 0721</p>

Fassadenprofile

aus Vollgummi bzw. Weich-PVC

GUK



05 F 0722



05 F 0724



05 F 0725

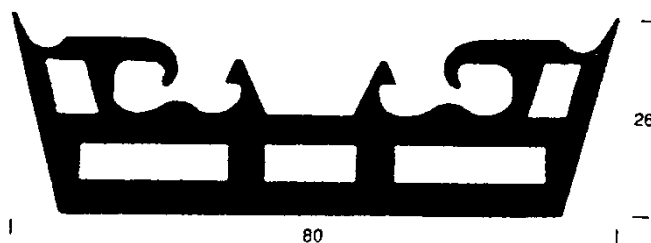

05 F 0726

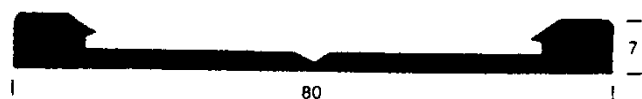

05 F 0727

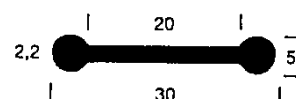

05 F 0837

Fassadenprofile

aus Vollgummi bzw. Weich-PVC

GUK



05 F 0916

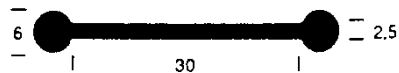

05 F 0922



05 F 0925

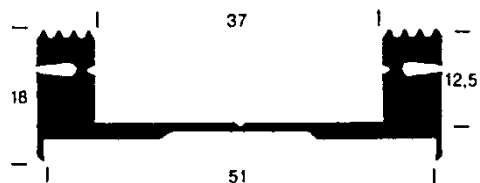

05 F 0929

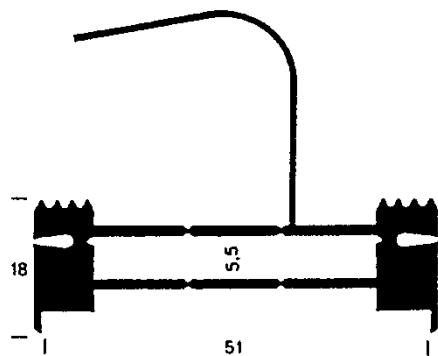

05 F 0930

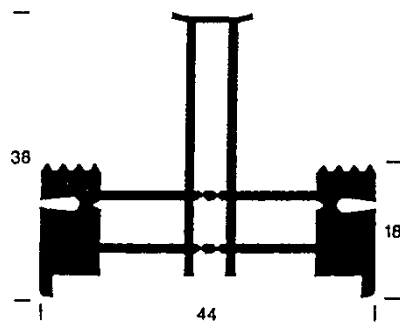

05 F 0981

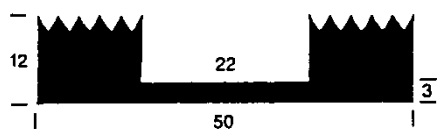

05 F 0984



05 F 1140

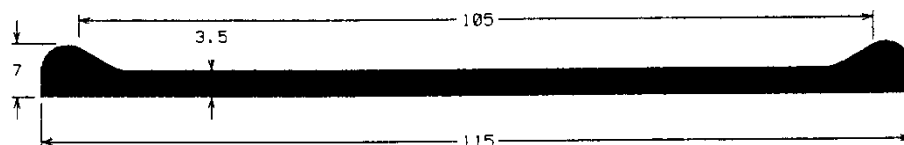

05 F 1244

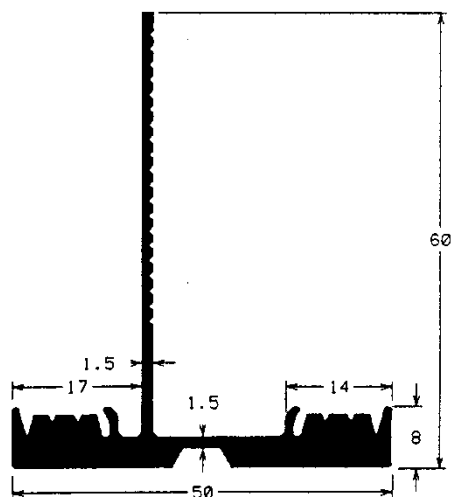

05 F 1246

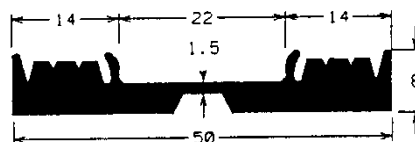

05 F 1247



05 F 1287

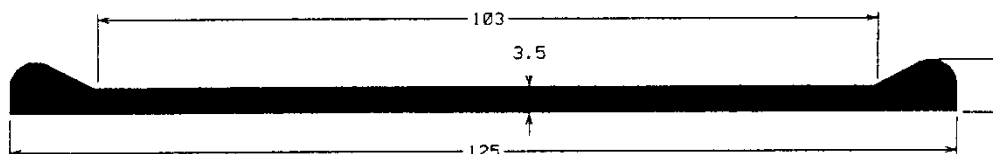

05 F 1271

Fassadenprofile

aus Vollgummi bzw. Weich-PVC

GUK

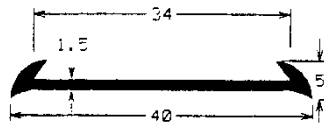

05 F 1294

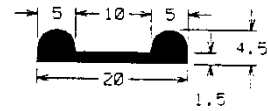

05 F 1313

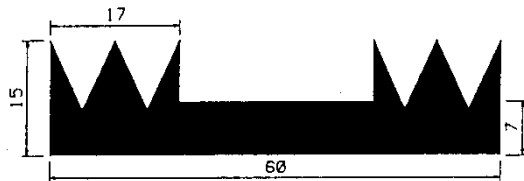

05 F 1359

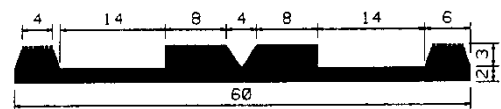

05 F 1387

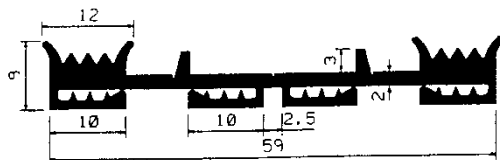

05 F 1410

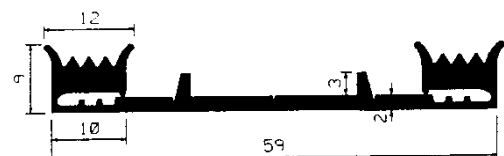

05 F 1411

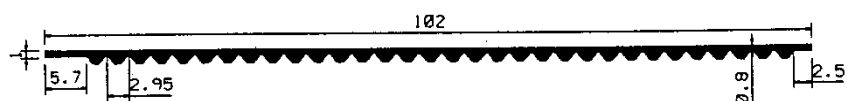

05 F 1420