

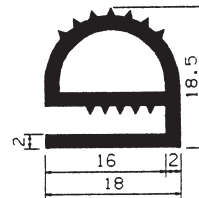

# Rolltor- und Fingerschutzprofile

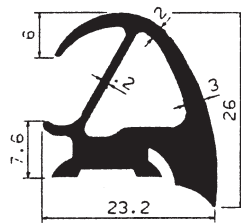

# Rolltor- und Fingerschutzprofile

aus Vollgummi bzw. Weich-PVC

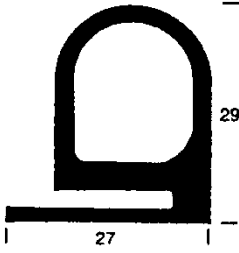
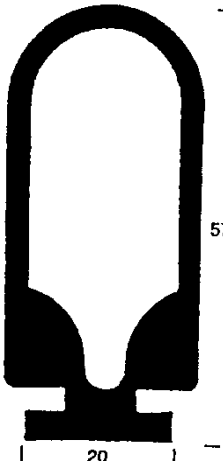
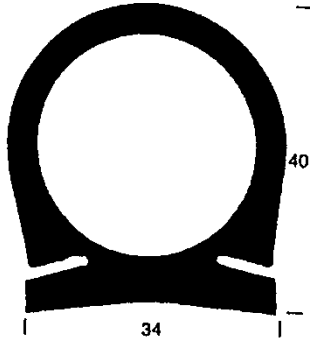
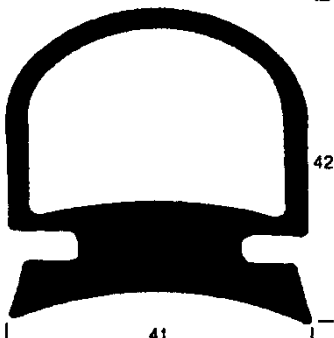
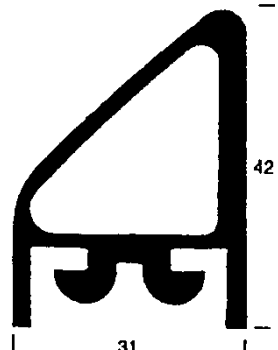
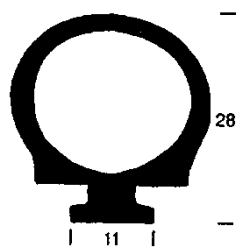
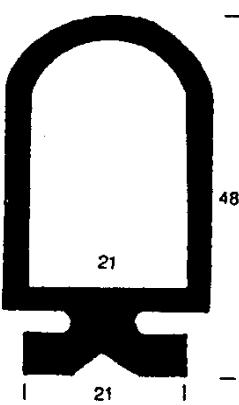
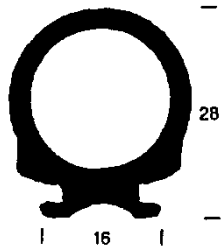
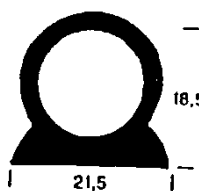



# GUK

 <p>05 RT 0261</p>	 <p>05 RT 0272</p>	 <p>05 RT 0273</p>
 <p>05 RT 0274</p>	 <p>05 RT 0275</p>	
 <p>05 RT 0309</p>	 <p>05 RT 0355</p>	 <p>05 RT 0366</p>
 <p>05 RT 0387</p>	 <p>05 RT 0407</p>	

# Rolltor- und Fingerschutzprofile

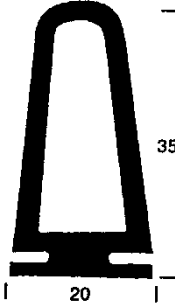
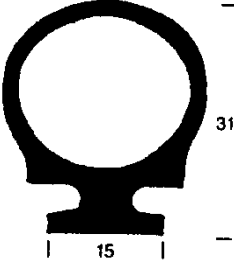
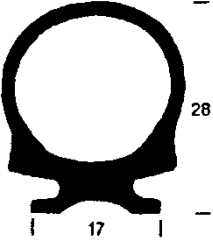
aus Vollgummi bzw. Weich-PVC

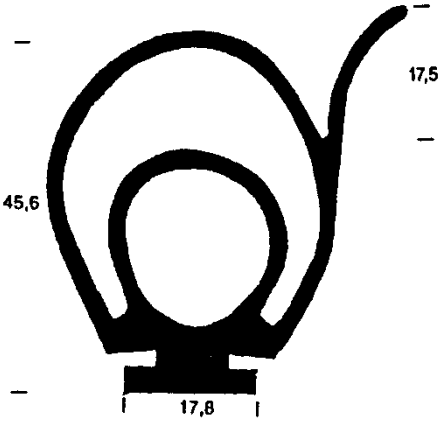
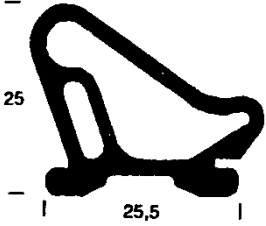
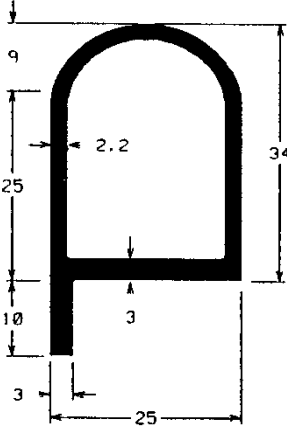
# GUK

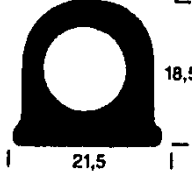
 <p>05 RT 0411</p>	 <p>05 RT 0424</p>	 <p>05 RT 0425</p>
 <p>05 RT 0431</p>	 <p>05 RT 0474</p>	
 <p>05 RT 0476</p>	 <p>05 RT 0509</p>	
 <p>05 RT 0506</p>	 <p>05 RT 0558</p>	

# Rolltor- und Fingerschutzprofile

aus Vollgummi bzw. Weich-PVC

# GUK

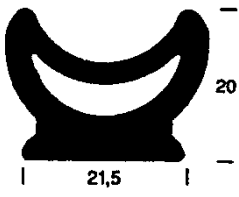
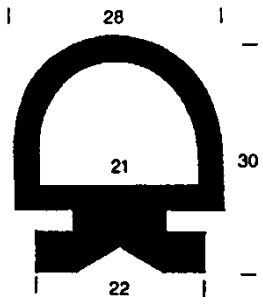
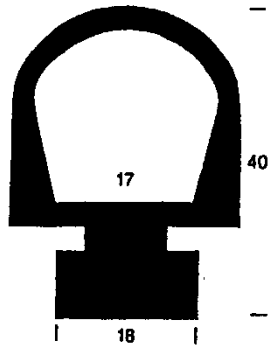
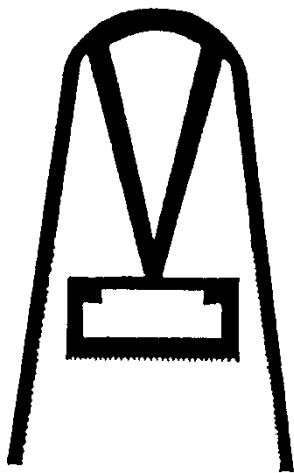
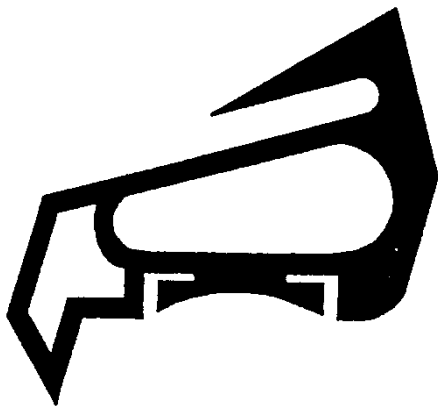
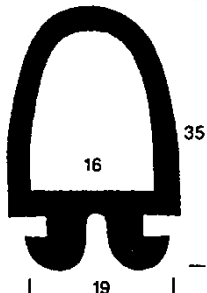
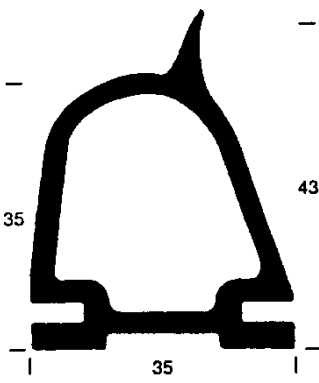
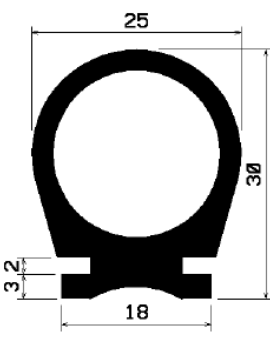
 <p>05 RT 0559</p>	 <p>05 RT 0591</p>	 <p>05 RT 0621</p>
 <p>05 RT 0665</p>	 <p>05 RT 0733</p>	
 <p>05 RT 0735</p>	 <p>05 RT 0782</p>	 <p>05 RT 0792</p>

# Rolltor- und Fingerschutzprofile

aus Vollgummi bzw. Weich-PVC

# GUK

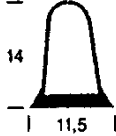
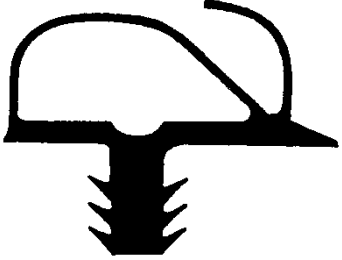
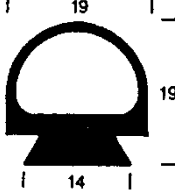
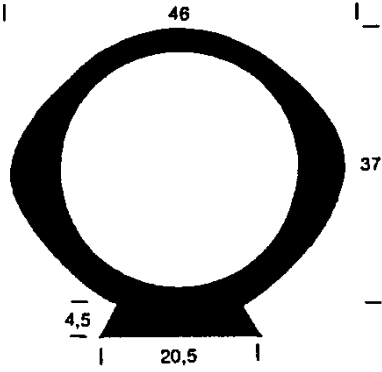
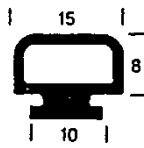
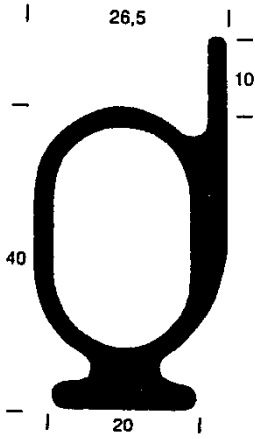
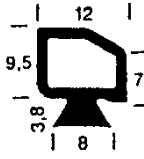
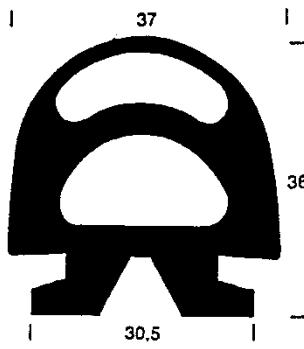
 <p>05 RT 0838</p>	 <p>05 RT 0887</p>	 <p>05 RT 0891</p>
 <p>05 RT 0920</p>	 <p>05 RT 0949</p>	 <p>05 RT 0951</p>
 <p>05 RT 0961</p>	 <p>05 RT 0952</p>	
 <p>05 RT 0994</p>		

# Rolltor- und Fingerschutzprofile

aus Vollgummi bzw. Weich-PVC

# GUK

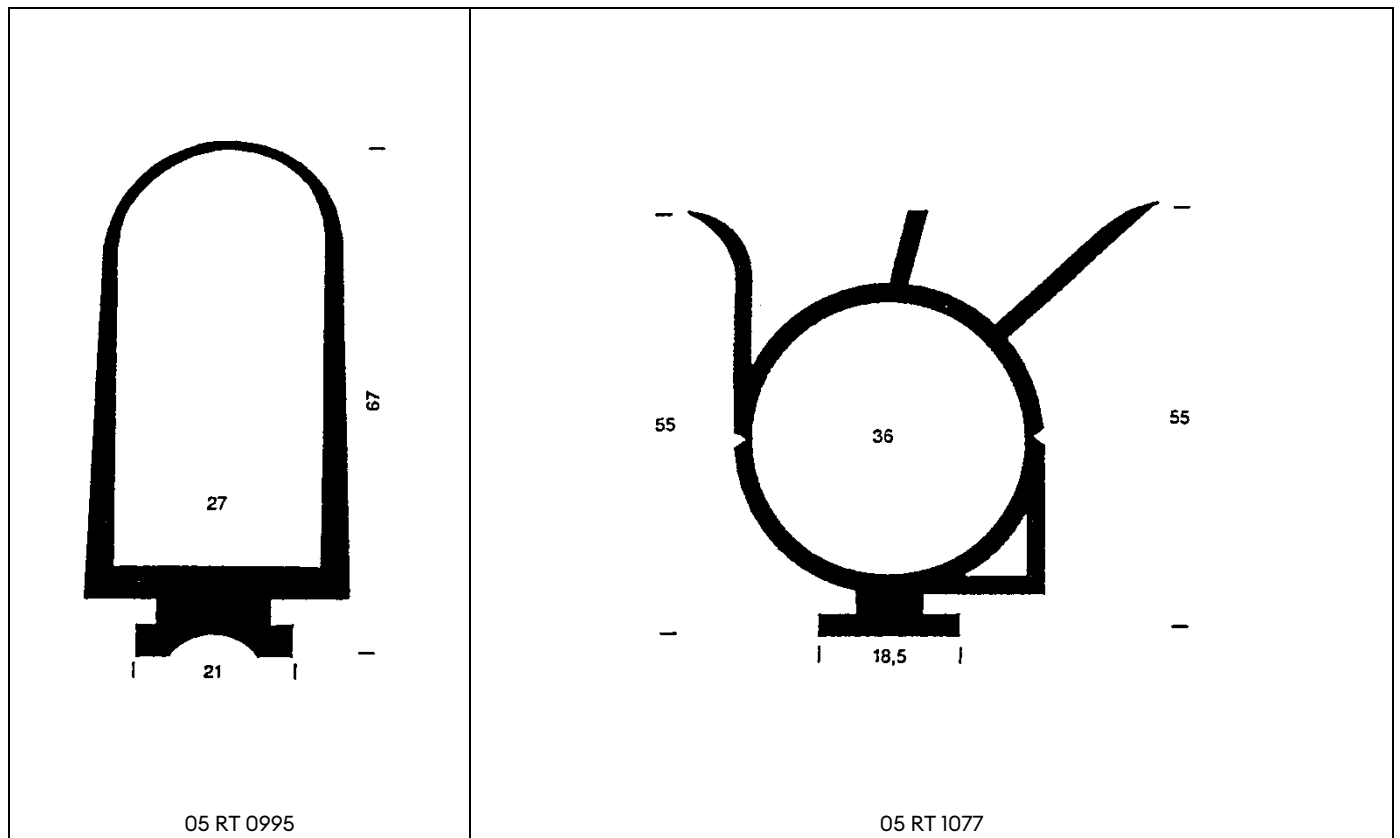

05 RT 0995

05 RT 1077

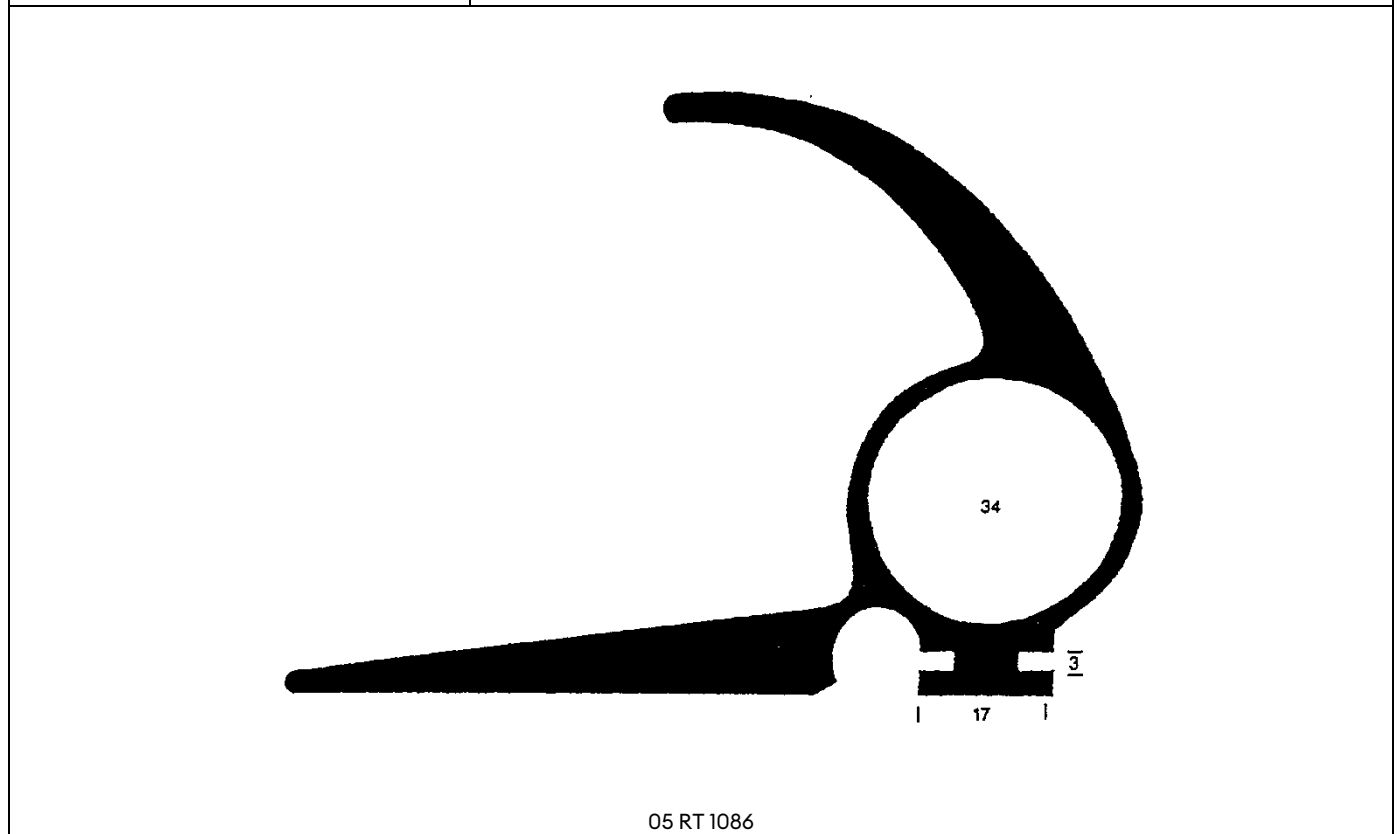

05 RT 1086

# Rolltor- und Fingerschutzprofile

aus Vollgummi bzw. Weich-PVC

# GUK

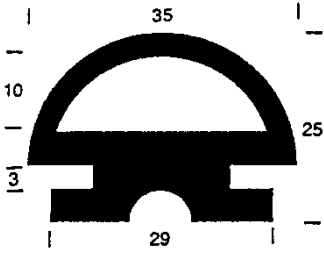
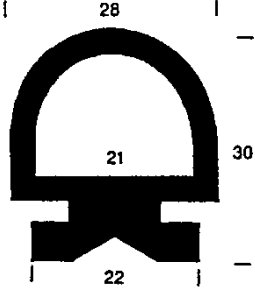
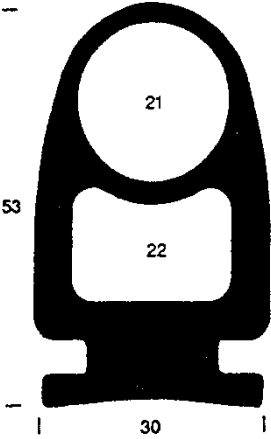
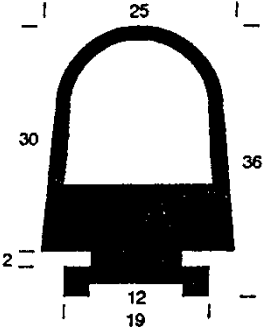
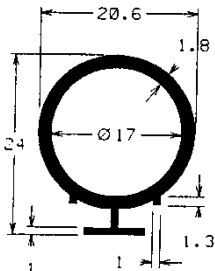
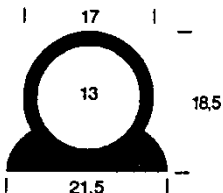
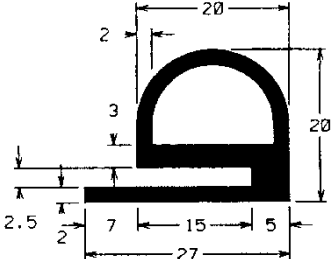
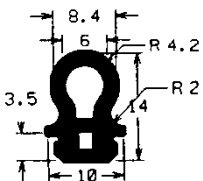
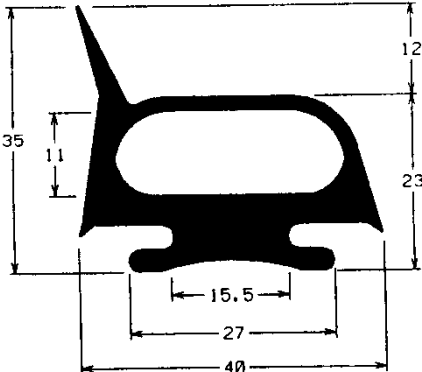
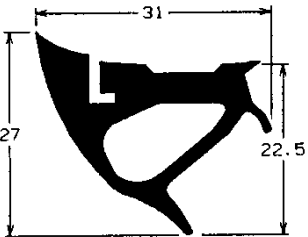
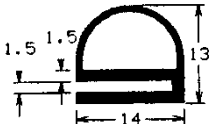
 <p>05 RT 1088</p>	 <p>05 RT 1102</p>	 <p>05 RT 1188</p>
 <p>05 RT 1192</p>	 <p>05 RT 1194</p>	
 <p>05 RT 1214</p>	 <p>05 RT 1227</p>	 <p>05 RT 1241</p>
 <p>05 RT 1274</p>	 <p>05 RT 1279</p>	 <p>05 RT 1297</p>

# Rolltor- und Fingerschutzprofile

aus Vollgummi bzw. Weich-PVC

# GUK

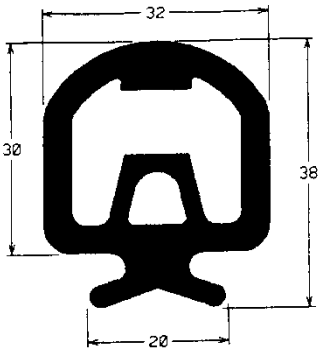
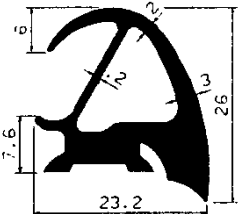
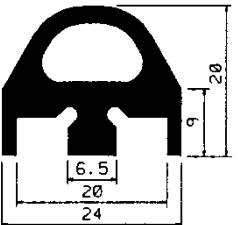
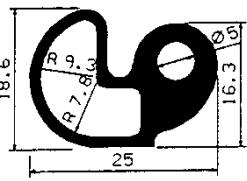
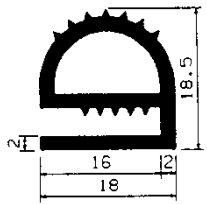
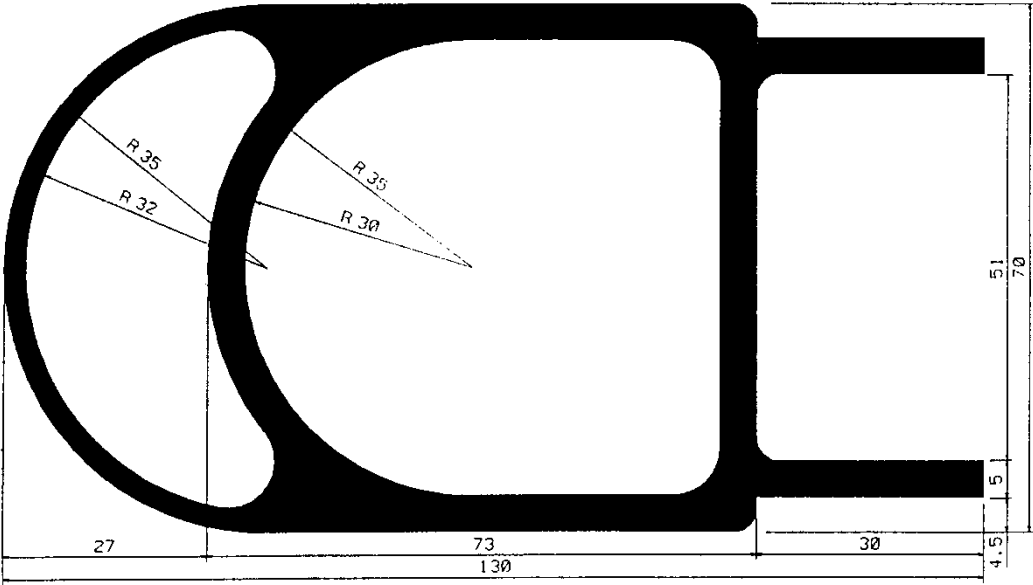
 <p>05 RT 1326</p>	 <p>05 RT 1364</p>	 <p>05 RT 1368</p>
 <p>05 RT 1376</p>	 <p>05 RT 1399</p>	
 <p>05 RT 1369</p>		



# Rolltor- und Fingerschutzprofile

aus Vollgummi bzw. Weich-PVC

# GUK

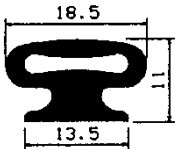
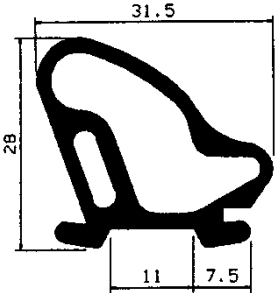
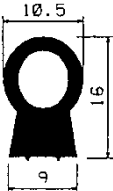
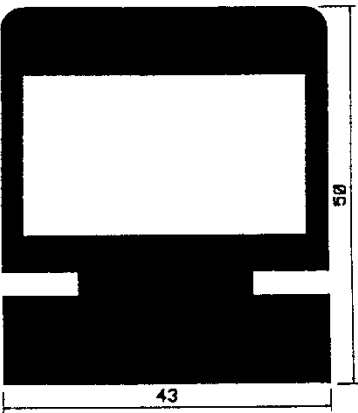
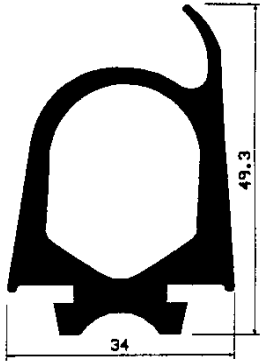
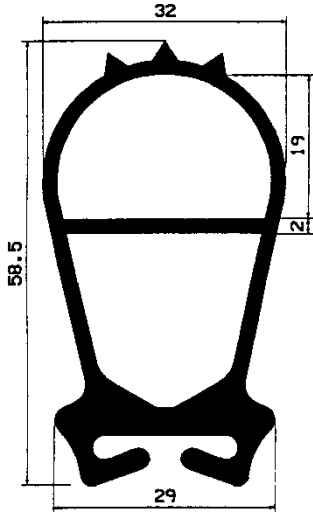
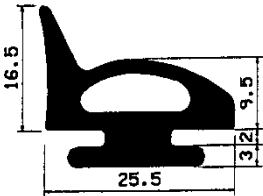
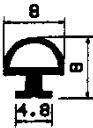
 <p>Technical drawing of profile 05 RT 1418. Dimensions: 18.5 (width), 13.5 (width), 11 (height).</p>	 <p>Technical drawing of profile 05 RT 1425. Dimensions: 31.5 (width), 28 (height), 11 (width), 7.5 (width).</p>	 <p>Technical drawing of profile 05 RT 1435. Dimensions: 10.5 (width), 1.6 (height), 9 (width).</p>
 <p>Technical drawing of profile 05 RT 1453. Dimensions: 43 (width), 50 (height).</p>	 <p>Technical drawing of profile 05 RT 1502. Dimensions: 49.3 (height), 34 (width).</p>	 <p>Technical drawing of profile 05 RT 1517. Dimensions: 32 (width), 58.5 (height), 19 (height), 2 (width), 29 (width).</p>
 <p>Technical drawing of profile 05 RT 1503. Dimensions: 16.5 (height), 25.5 (width), 9.5 (height), 3.2 (width).</p>	 <p>Technical drawing of profile 05 RT 1530. Dimensions: 8 (width), 8 (height), 4.8 (width).</p>	

# Rolltor- und Fingerschutzprofile

aus Vollgummi bzw. Weich-PVC

# GUK

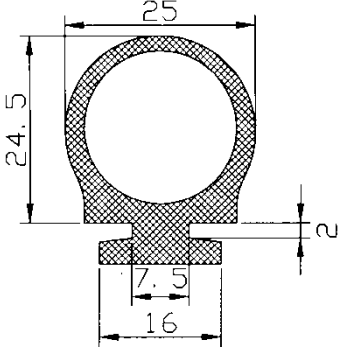
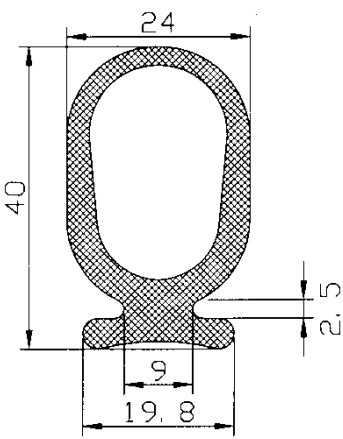
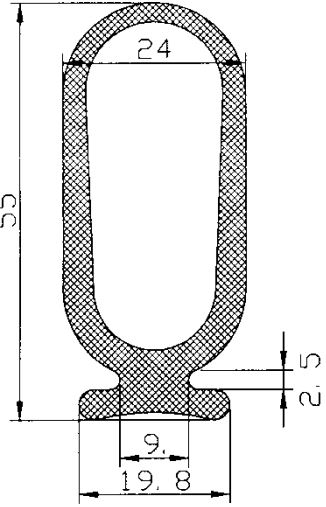
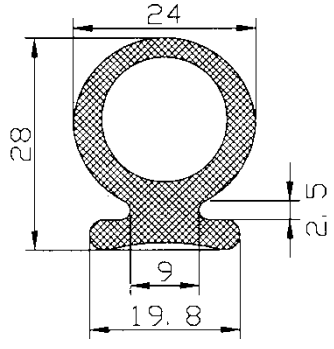
 <p>02 G 2011</p> <p>Dimensions: 25 (width), 24.5 (height), 7.5 (inner width), 16 (base width), 2 (thickness)</p>	 <p>02 D 1128</p> <p>Dimensions: 24 (width), 40 (height), 9 (inner width), 19.8 (base width), 2.5 (thickness)</p>	 <p>02 D 1135</p> <p>Dimensions: 24 (width), 55 (height), 9 (inner width), 19.8 (base width), 2.5 (thickness)</p>
 <p>02 D 1133</p> <p>Dimensions: 24 (width), 28 (height), 9 (inner width), 19.8 (base width), 2.5 (thickness)</p>		