

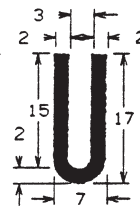

Technische U-Profile

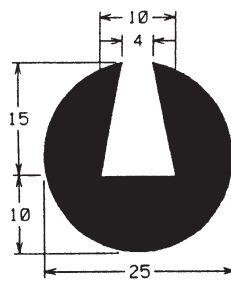
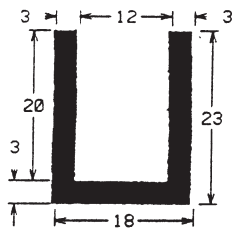

Technische U-Profile

aus Vollgummi bzw. Weich-PVC

GUK

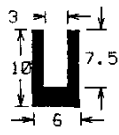
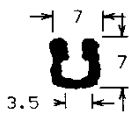
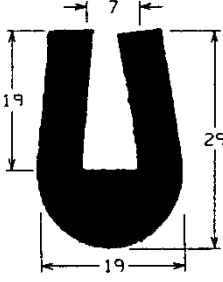
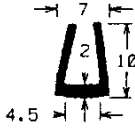
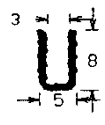
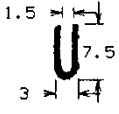
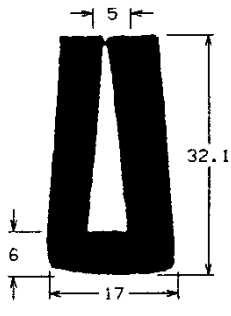
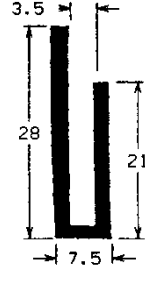
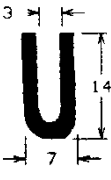
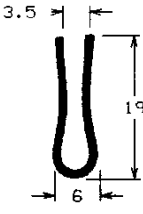
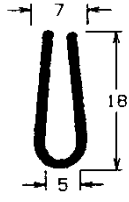
 <p>05 TUI 0040 KS</p>	 <p>05 TUI 0070</p>	 <p>05 TUI 0111 KS</p>
 <p>05 TUI 0112</p>	 <p>05 TUI 0113 Si</p>	 <p>05 TUI 0116 KS</p>
 <p>05 TUI 0121</p>	 <p>05 TUI 0154</p>	 <p>05 TUI 0181</p>
 <p>05 TUI 0186</p>	 <p>05 TUI 0228</p>	 <p>05 TUI 0229</p>

Technische U-Profile

aus Vollgummi bzw. Weich-PVC



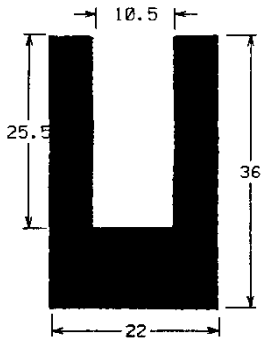
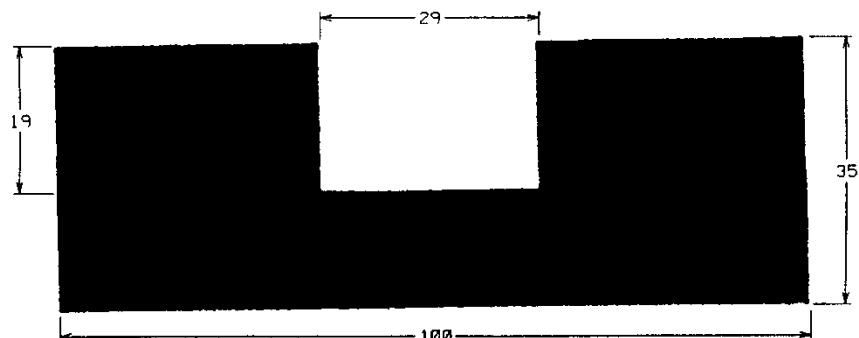
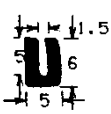
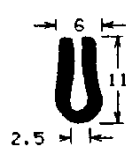
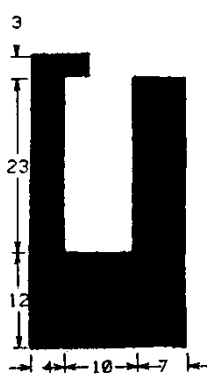
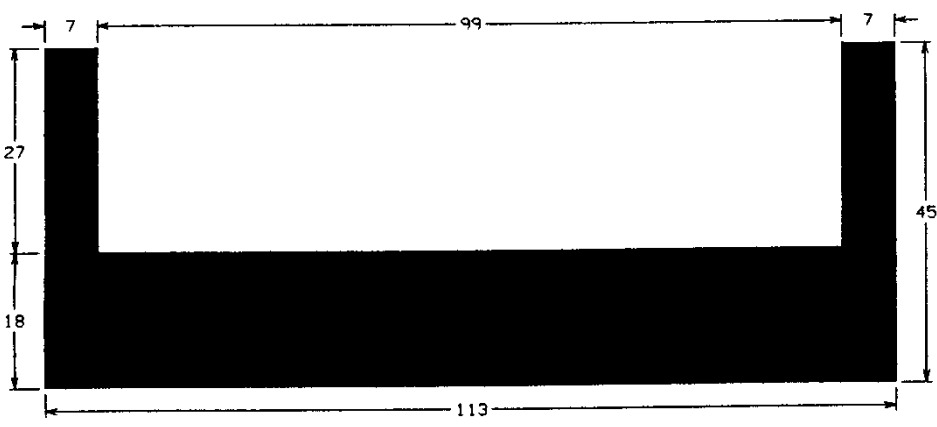

GUK

 <p>05 TU1 0233</p>	 <p>05 TU1 0246</p>	
 <p>05 TU1 0290</p>	 <p>05 TU1 0292</p>	 <p>05 TU1 0299</p>
 <p>05 TU1 0304</p>		

Technische U-Profile

aus Vollgummi bzw. Weich-PVC

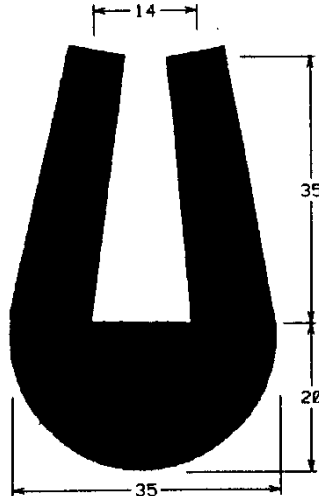
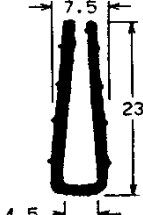
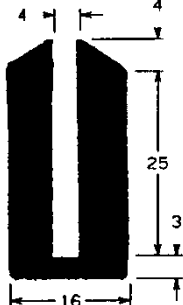
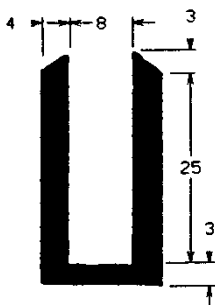
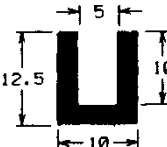
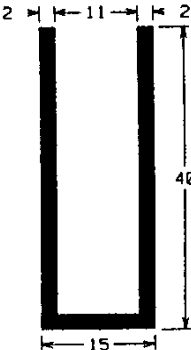
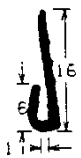

GUK

 <p>05 TUI 0305 KS</p>	 <p>05 TUI 0306 KS</p>	 <p>05 TUI 0317 Si</p>
 <p>05 TUI 0320</p>	 <p>05 TUI 0338</p>	 <p>05 TUI 0350</p>
 <p>05 TUI 0367</p>	 <p>05 TUI 0368</p>	
 <p>05 TUI 0370</p>	 <p>05 TUI 0371</p>	 <p>05 TUI 0378</p>

Technische U-Profile

aus Vollgummi bzw. Weich-PVC

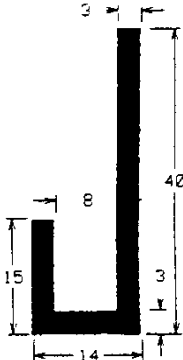
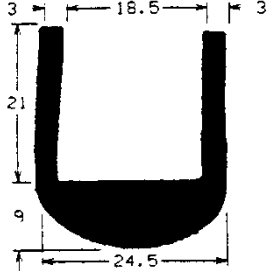
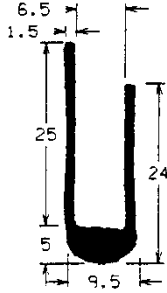
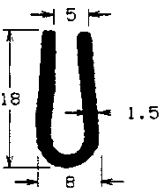

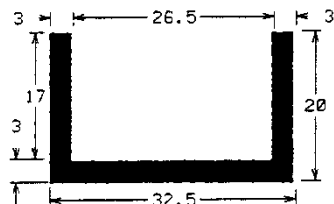
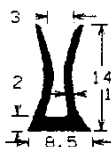
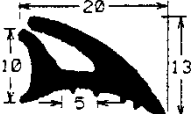
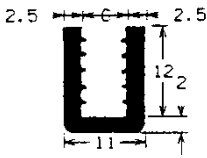
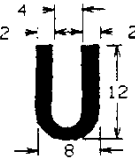
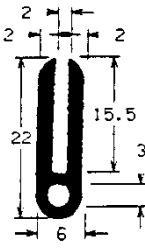
GUK

 <p>05 TUI 0396 KS</p>	 <p>05 TUI 0402</p>	 <p>05 TUI 0409</p>
 <p>05 TUI 0418</p>	 <p>05 TUI 0421</p>	 <p>05 TUI 0426 NBR</p>
 <p>05 TUI 0435</p>	 <p>05 TUI 0444</p>	 <p>05 TUI 0469</p>
 <p>05 TUI 0483 KS</p>	 <p>05 TUI 0484</p>	 <p>05 TUI 0529</p>

Technische U-Profile

aus Vollgummi bzw. Weich-PVC

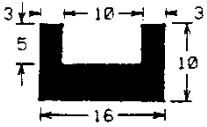
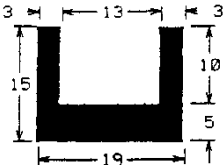
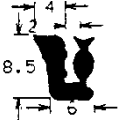
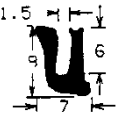
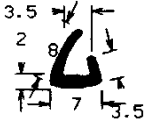
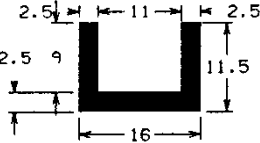
GUK

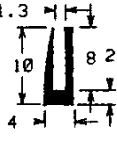
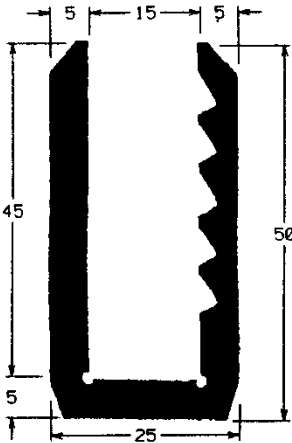
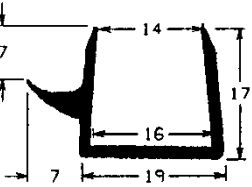
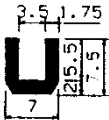
 <p>Technical drawing of U-profile 05 TUI 0533. Dimensions: top flange width 10, top flange height 3, bottom flange width 16, bottom flange height 5, total height 10.</p>	 <p>Technical drawing of U-profile 05 TUI 0534. Dimensions: top flange width 13, top flange height 3, bottom flange width 19, bottom flange height 5, total height 10.</p>	 <p>Technical drawing of U-profile 05 TUI 0545. Dimensions: top flange width 4, top flange height 2, bottom flange width 6, bottom flange height 8.5.</p>
 <p>Technical drawing of U-profile 05 TUI 0561 EP. Dimensions: top flange width 1.5, top flange height 1, bottom flange width 7, bottom flange height 6.</p>	 <p>Technical drawing of U-profile 05 TUI 0578. Dimensions: top flange width 3.5, top flange height 2, bottom flange width 7, bottom flange height 3.5.</p>	 <p>Technical drawing of U-profile 05 TUI 0596. Dimensions: top flange width 11, top flange height 2.5, bottom flange width 16, bottom flange height 11.5.</p>
 <p>Technical drawing of U-profile 05 TUI 0598. Dimensions: top flange width 1.3, top flange height 4, bottom flange width 4, bottom flange height 10.</p>	 <p>Technical drawing of U-profile 05 TU 0599. Dimensions: top flange width 1.3, top flange height 4, bottom flange width 4, bottom flange height 10.</p>	 <p>Technical drawing of U-profile 05 TUI 0608. Dimensions: top flange width 5, top flange height 15, bottom flange width 25, bottom flange height 5, total height 50.</p>
 <p>Technical drawing of U-profile 05 TU 0603. Dimensions: top flange width 14, top flange height 7, bottom flange width 16, bottom flange height 7, total height 17.</p>	 <p>Technical drawing of U-profile 05 TUI 0605. Dimensions: top flange width 3.5, top flange height 1.75, bottom flange width 7, bottom flange height 7.5.</p>	

Technische U-Profile

aus Vollgummi bzw. Weich-PVC

GUK

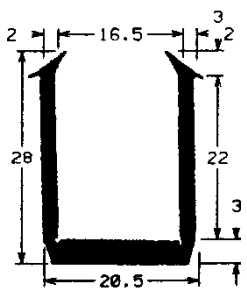
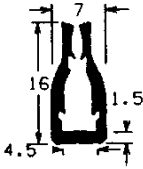
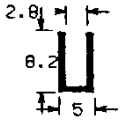
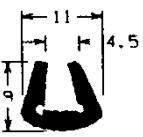
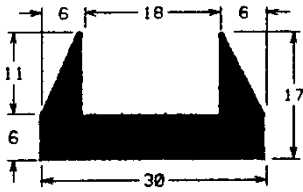
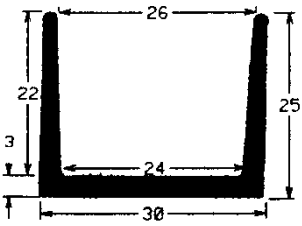
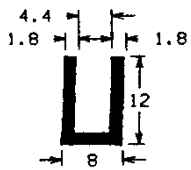
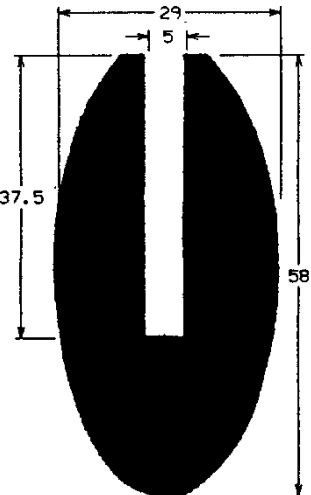
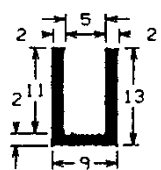
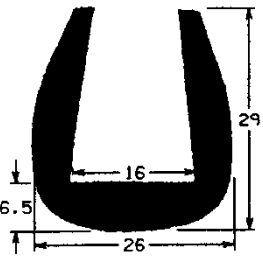
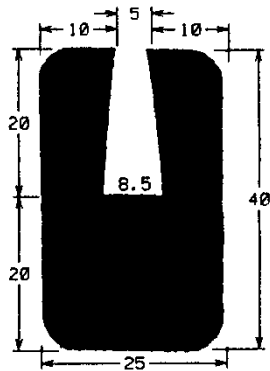
 <p>Technical drawing of U-profile 05 TUI 0611. Dimensions: top flange width 16.5, top flange thickness 2, top flange height 3, total height 28, bottom flange width 20.5, bottom flange thickness 3, bottom flange height 22.</p>	 <p>Technical drawing of U-profile 05 TUI 0614. Dimensions: top flange width 7, top flange height 16, bottom flange width 4.5, bottom flange height 1.5.</p>	 <p>Technical drawing of U-profile 05 TUI 0620. Dimensions: top flange width 2.8, top flange height 8.2, bottom flange width 5.</p>
 <p>Technical drawing of U-profile 05 TUI 0643 KS. Dimensions: top flange width 11, top flange height 4.5.</p>	 <p>Technical drawing of U-profile 05 TUI 0648 Si. Dimensions: top flange width 18, top flange height 6, total height 17, bottom flange width 30, bottom flange height 6.</p>	 <p>Technical drawing of U-profile 05 TUI 0667. Dimensions: top flange width 26, top flange height 22, total height 25, bottom flange width 30, bottom flange height 3.</p>
 <p>Technical drawing of U-profile 05 TUI 0672. Dimensions: top flange width 4.4, top flange height 1.8, total height 12, bottom flange width 8.</p>	 <p>Technical drawing of U-profile 05 TUI 0694. Dimensions: top flange width 29, top flange height 5, total height 37.5, bottom flange height 58.</p>	 <p>Technical drawing of U-profile 05 TUI 0695. Dimensions: top flange width 5, top flange height 2, total height 13, bottom flange width 9.</p>
 <p>Technical drawing of U-profile 05 TUI 0734. Dimensions: top flange width 16, top flange height 6.5, total height 29, bottom flange width 26.</p>	 <p>Technical drawing of U-profile 05 TUI 0736. Dimensions: top flange width 5, top flange height 10, total height 40, bottom flange width 25, bottom flange height 20.</p>	

Technische U-Profile

aus Vollgummi bzw. Weich-PVC

GUK



05 TU1 0746

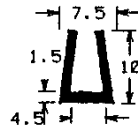

05 TU1 0755 Si

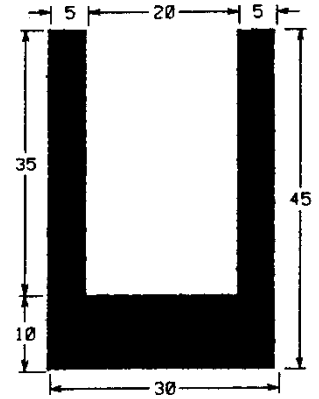

05 TU1 0756

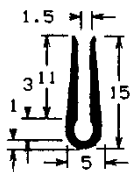

05 TU1 0758



05 TU1 0764

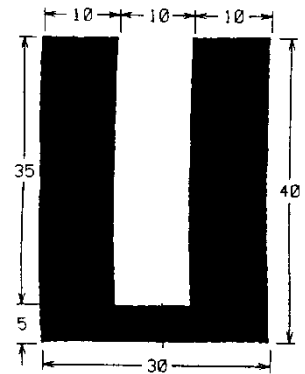

05 TU1 0772

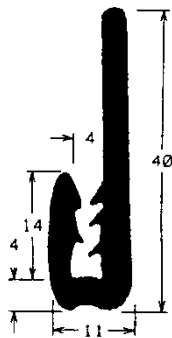

05 TU1 0781

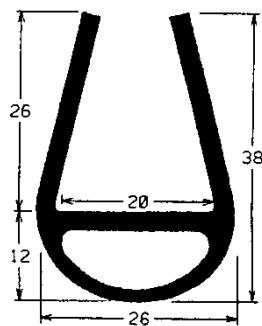

05 TU1 0796

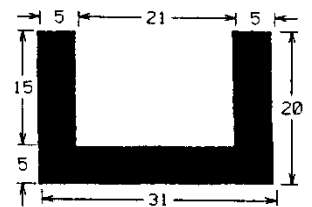

05 TU1 0798

Technische U-Profile

aus Vollgummi bzw. Weich-PVC

GUK

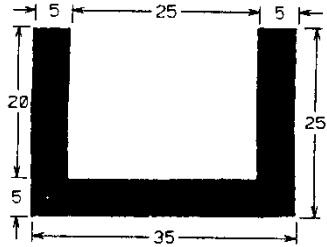

05 TU1 0799

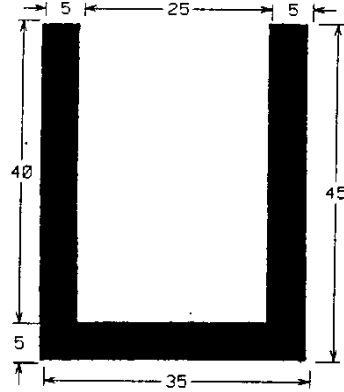

05 TU1 0801

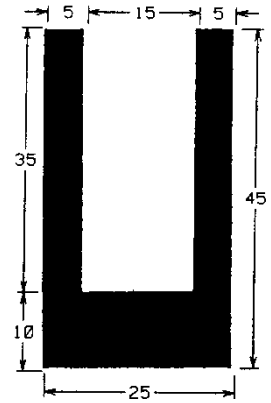

05 TU1 0802

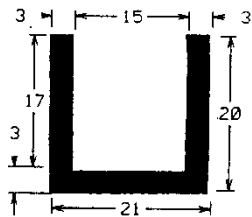

05 TU1 0805

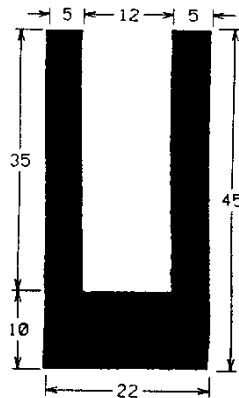

05 TU1 0806

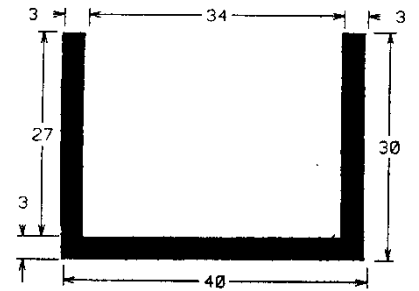

05 TU1 0815

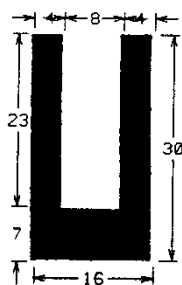

05 TU1 0817

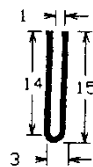

05 TU1 0843

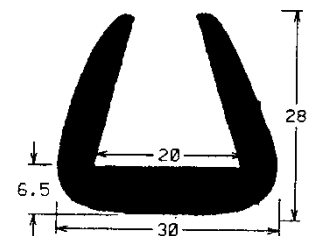

05 TU 0846

Technische U-Profile

aus Vollgummi bzw. Weich-PVC

GUK

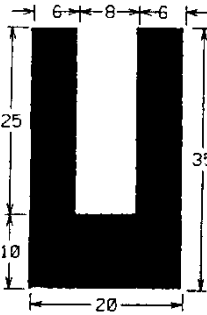
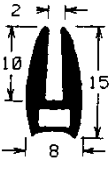
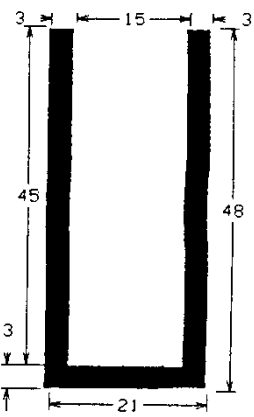
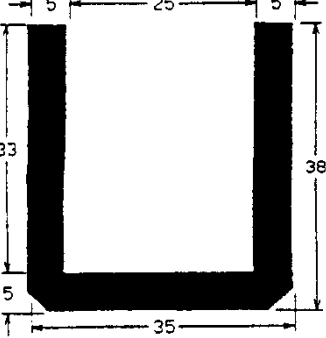
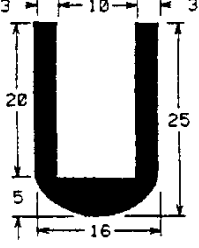
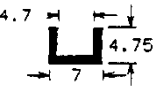
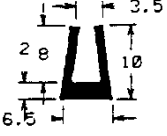
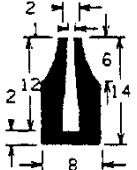
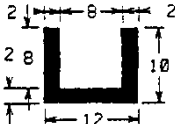
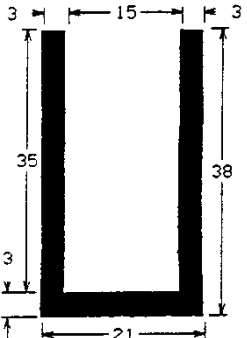
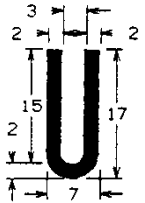
 <p>05 TU1 0851 Si</p>	 <p>05 TU1 0852</p>	 <p>05 TU1 0854</p>
 <p>05 TU1 0876</p>	 <p>05 TU1 0879</p>	
 <p>05 TU1 0880</p>	 <p>05 TU1 0882</p>	 <p>05 TU1 0889</p>
 <p>05 TU1 0894</p>	 <p>05 TU1 0899</p>	 <p>05 TU1 0905</p>

Technische U-Profile

aus Vollgummi bzw. Weich-PVC

GUK

<p>05 TUI 0909</p>	<p>05 TUI 0924</p>	<p>05 TUI 0931</p>
<p>05 TUI 0947</p>	<p>05 TUI 0948</p>	<p>05 TUI 0957</p>
<p>05 TUI 0946</p>	<p>05 TUI 0968</p>	

Technische U-Profile

aus Vollgummi bzw. Weich-PVC

GUK

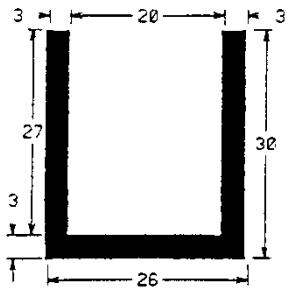

05 TU1 0971

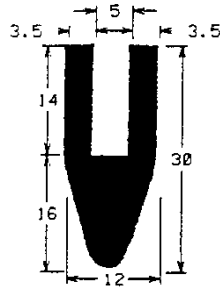

05 TU1 0987

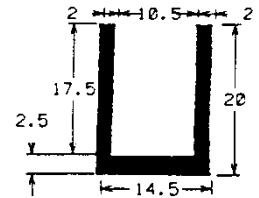

05 TU1 1000

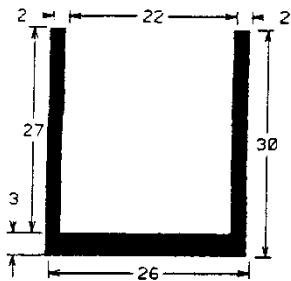

05 TU1 1006

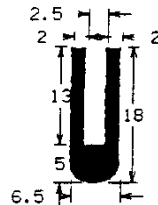

05 TU1 10011

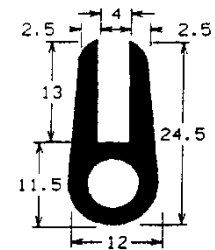

05 TU1 1022

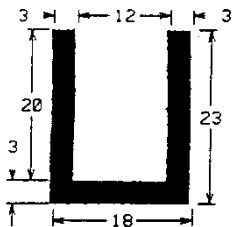

05 TU1 1023

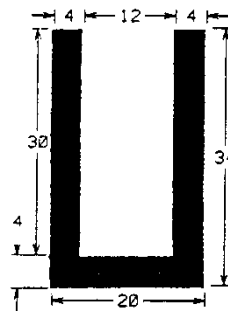

05 TU1 1024

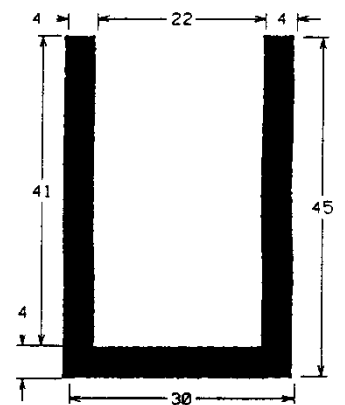

05 TU1 1033

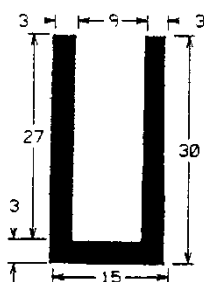

05 TU1 1028

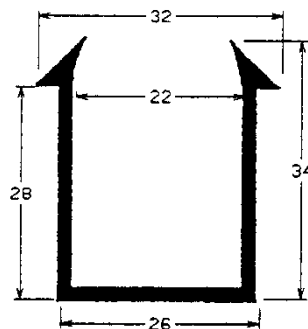

05 TU1 1030

Technische U-Profile

aus Vollgummi bzw. Weich-PVC

GUK

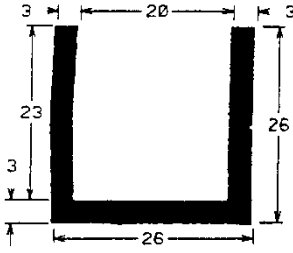
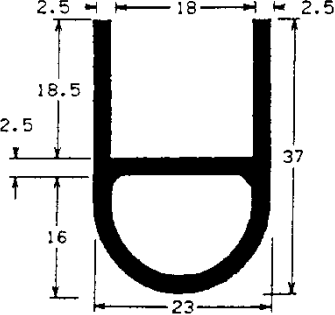
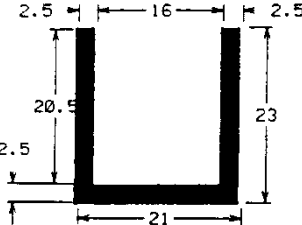
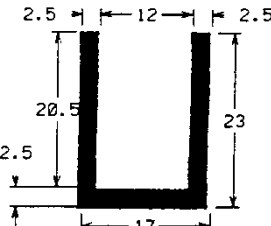
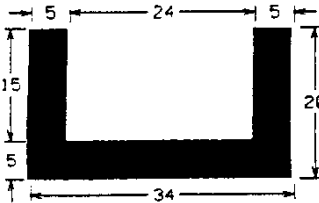
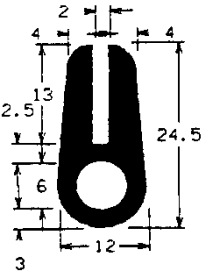
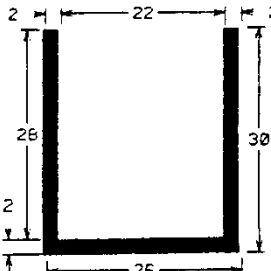
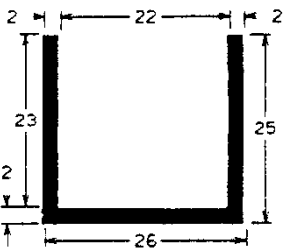
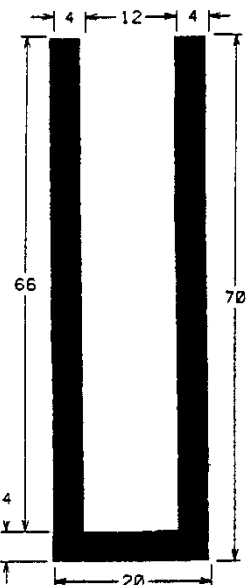
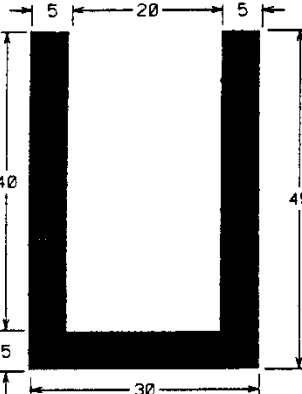
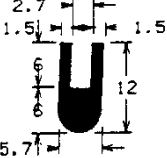
 <p>05 TU1 1034</p>	 <p>05 TU1 1035</p>	 <p>05 TU1 1036</p>
 <p>05 TU1 1042</p>	 <p>05 TU1 1043</p>	 <p>05 TU1 1044</p>
 <p>05 TU1 1045</p>	 <p>05 TU1 1046</p>	 <p>05 TU1 1048</p>
 <p>05 TU1 1049</p>	 <p>05 TU1 1050</p>	

Technische U-Profile

aus Vollgummi bzw. Weich-PVC

GUK

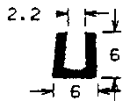
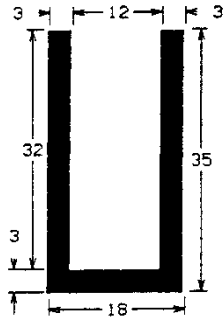
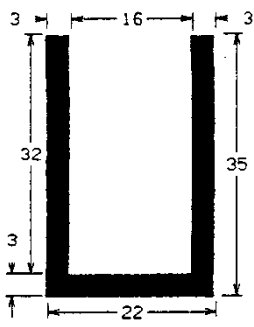
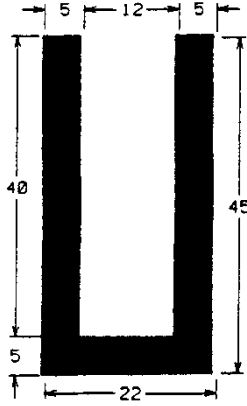
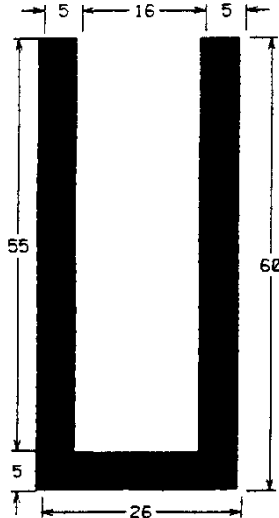
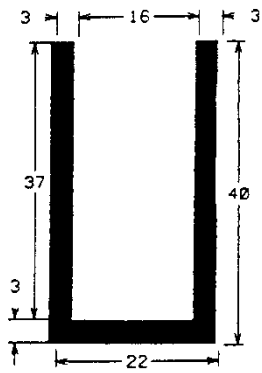
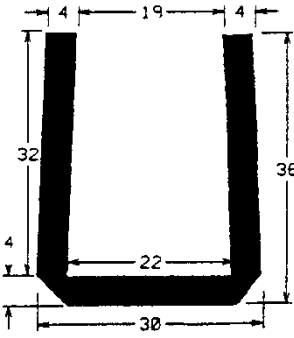
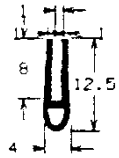
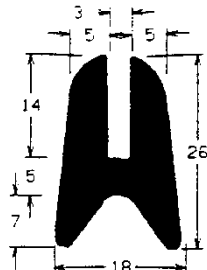
 <p>Technical drawing of U-profile 05 TU1 1051. Dimensions: top flange width 6, height 2.2, bottom flange width 6.</p>	 <p>Technical drawing of U-profile 05 TU1 1064. Dimensions: top flange width 18, height 32, side flange width 3, bottom flange width 18, total height 35.</p>	 <p>Technical drawing of U-profile 05 TU1 1065. Dimensions: top flange width 22, height 32, side flange width 3, bottom flange width 22, total height 35.</p>
 <p>Technical drawing of U-profile 05 TU1 1066. Dimensions: top flange width 22, height 40, side flange width 5, bottom flange width 22, total height 45.</p>	 <p>Technical drawing of U-profile 05 TU1 1067. Dimensions: top flange width 26, height 55, side flange width 5, bottom flange width 26, total height 60.</p>	 <p>Technical drawing of U-profile 05 TU1 1068. Dimensions: top flange width 22, height 37, side flange width 3, bottom flange width 22, total height 40.</p>
 <p>Technical drawing of U-profile 05 TU1 1070. Dimensions: top flange width 30, height 32, side flange width 4, bottom flange width 30, total height 36.</p>	 <p>Technical drawing of U-profile 05 TU1 1071. Dimensions: top flange width 8, height 12.5, side flange width 4, bottom flange width 4.</p>	 <p>Technical drawing of U-profile 05 TU1 1074. Dimensions: top flange width 18, height 14, side flange width 5, bottom flange width 18, total height 26.</p>

Technische U-Profile

aus Vollgummi bzw. Weich-PVC

GUK

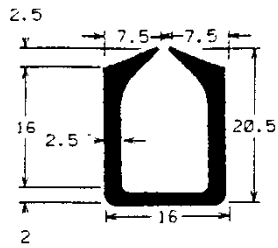

05 TU1 1075

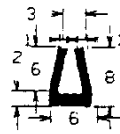

05 TU1 1078

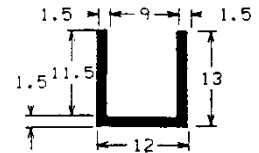

05 TU1 1080

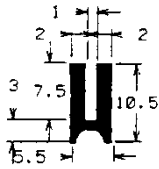

05 TU1 1082

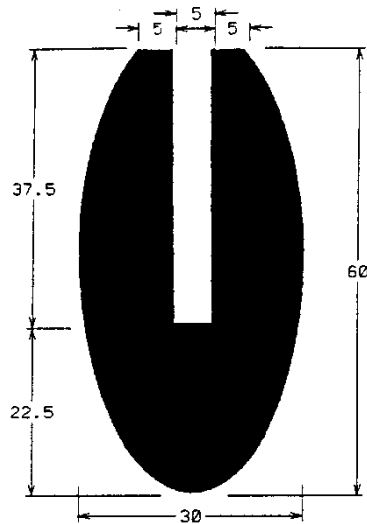

05 TU1 1083

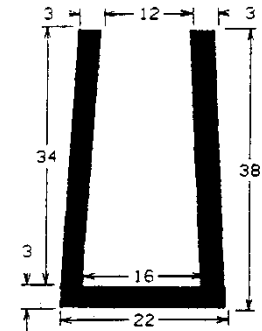

05 TU1 1089

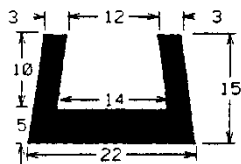

05 TU1 1090

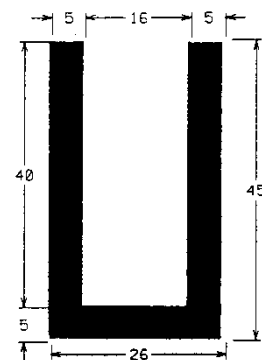

05 TU1 1111

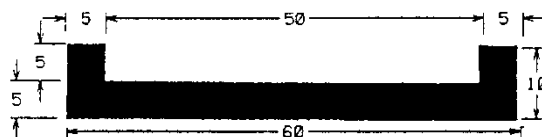

05 TU1 1101

Technische U-Profile

aus Vollgummi bzw. Weich-PVC

GUK

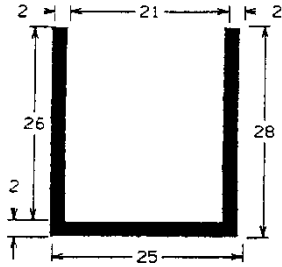

05 TU1 1113

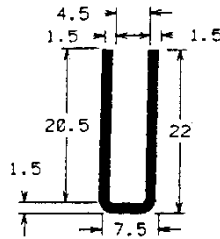

05 TU1 1128

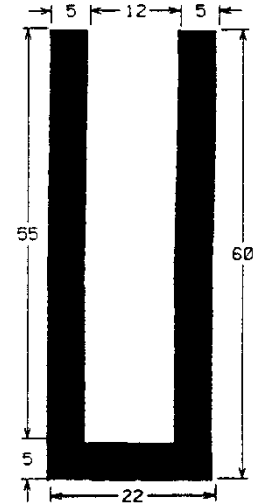

05 TU1 1117

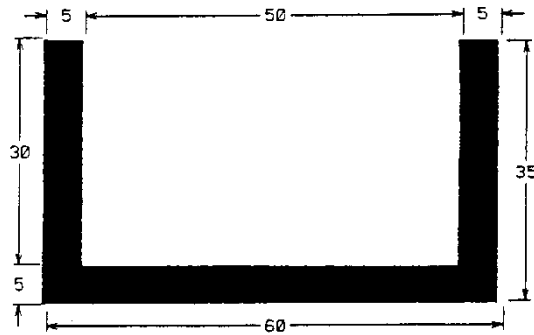

05 TU1 1130

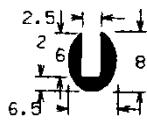

05 TU1 1132

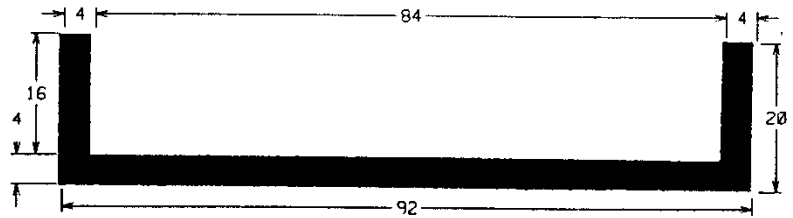

05 TU1 1148

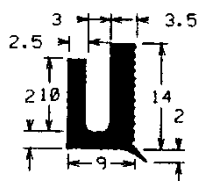

05 TU1 1143

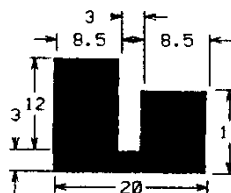

05 TU1 1152

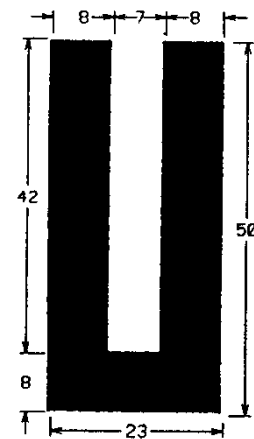

05 TU1 1164

Technische U-Profile

aus Vollgummi bzw. Weich-PVC

GUK

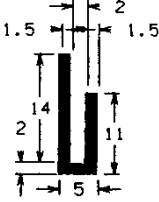
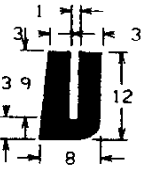
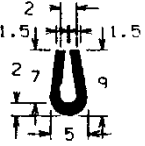
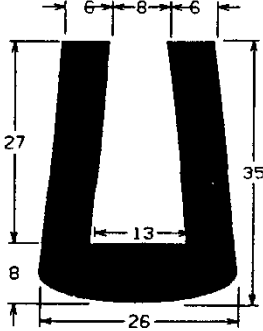
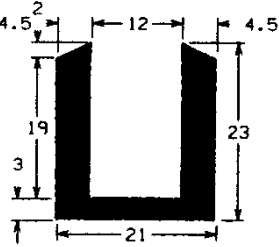
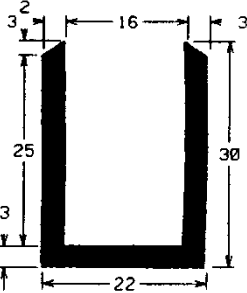
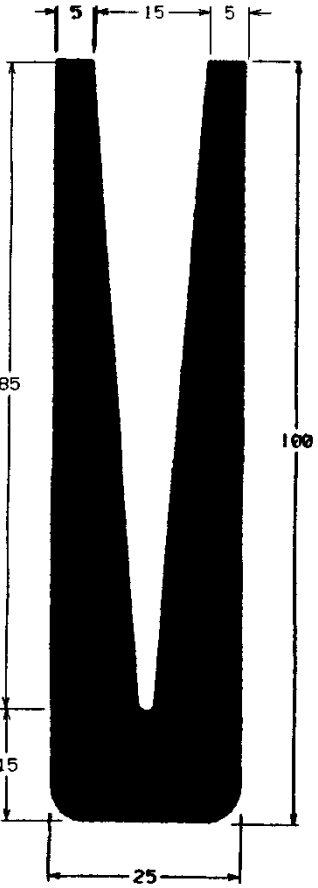
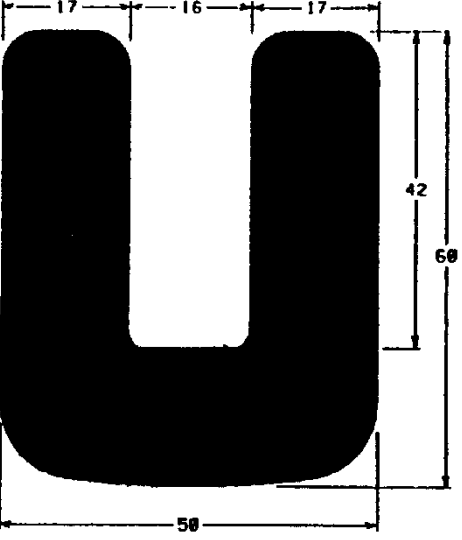
 <p>05 TU1 1181</p>	 <p>05 TU1 1182</p>	 <p>05 TU1 1184</p>
 <p>05 TU1 1202</p>	 <p>05 TU1 1204</p>	 <p>05 TU1 1222</p>
 <p>05 TU1 1228</p>	 <p>05 TU1 1231</p>	

Technische U-Profile

aus Vollgummi bzw. Weich-PVC

GUK

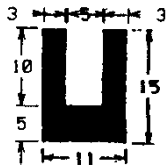

05 TU1 1263



05 TU1 1264

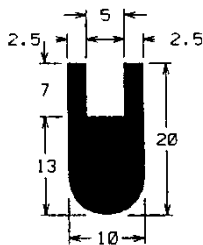

05 TU1 1278

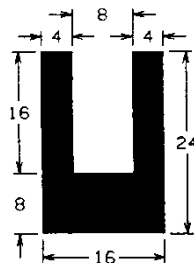

05 TU1 1281

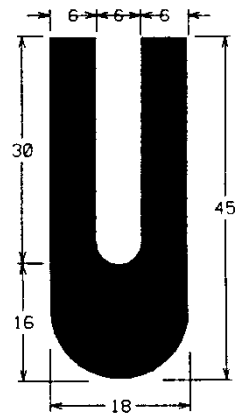

05 TU1 1276

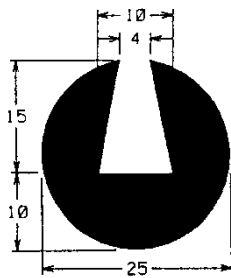

05 TU1 1286

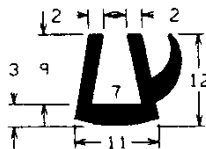

05 TU1 1292

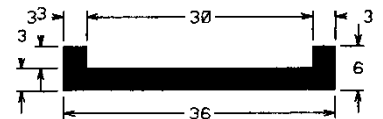

05 TU1 1298

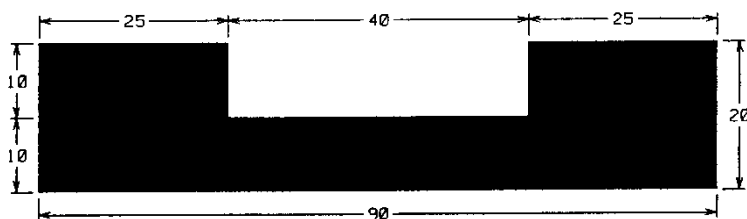

05 TU1 1324

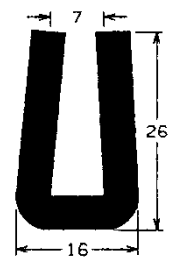





05 TU1 1325

Technische U-Profile

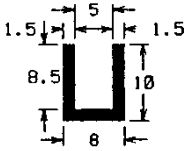
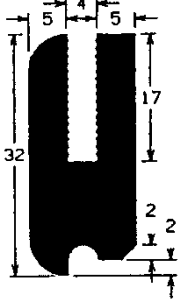
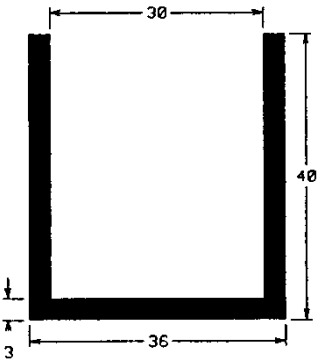
aus Vollgummi bzw. Weich-PVC

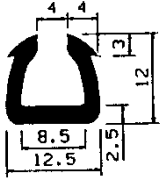

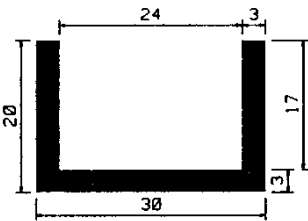
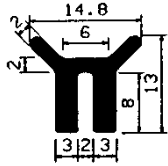
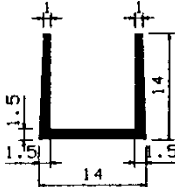
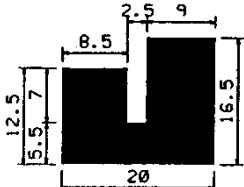
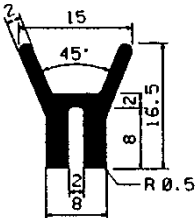

GUK

 <p>05 TU1 1329</p>	 <p>05 TU1 1332</p>	 <p>05 TU1 1335</p>
 <p>05 TU1 1353</p>	 <p>05 TU1 1363</p>	 <p>05 TU1 1370</p>
 <p>05 TU1 1382</p>	 <p>05 TU1 1393</p>	 <p>05 TU1 1396</p>
 <p>05 TU1 1404</p>	 <p>05 TU1 1407</p>	 <p>05 TU1 1408</p>

Technische U-Profile

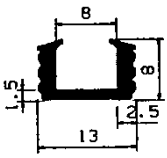
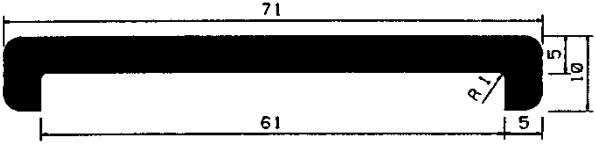
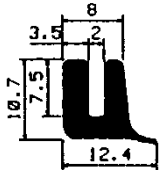
aus Vollgummi bzw. Weich-PVC

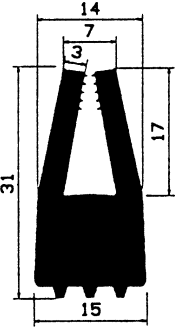

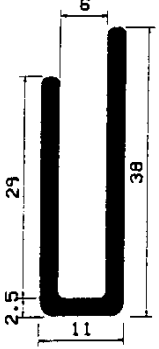
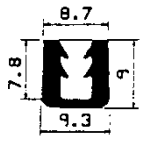
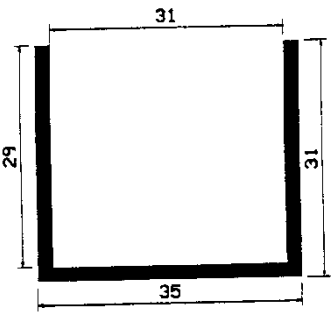
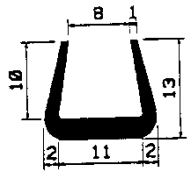
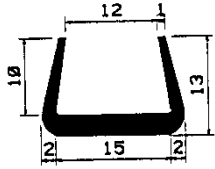
GUK

 <p>05 TUI 1416</p>	 <p>05 TUI 1419</p>	
 <p>05 TUI 1429</p>	 <p>05 TUI 1446</p>	 <p>05 TUI 1447</p>
 <p>05 TUI 1462</p>	 <p>05 TUI 1470</p>	 <p>05 TUI 1480</p>
 <p>05 TUI 1490</p>	 <p>05 TUI 1495</p>	 <p>05 TUI 1496</p>

Technische U-Profile

aus Vollgummi bzw. Weich-PVC

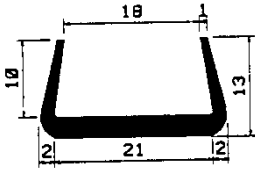
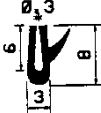
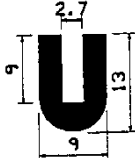
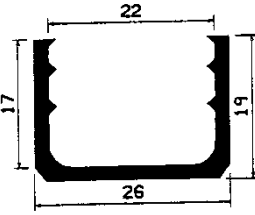
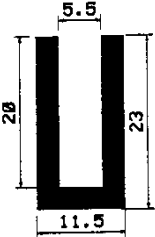
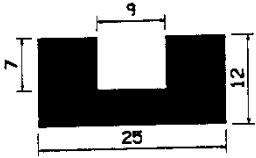
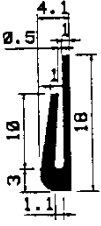
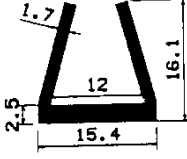
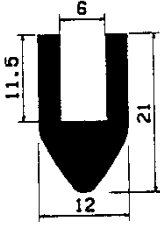

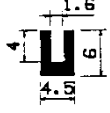
GUK

 <p>Technical drawing of U-profile 05 TU1 1497. Dimensions: top width 18, bottom width 21, height 13, side thickness 2, top flange height 10, and bottom flange height 2.</p>	 <p>Technical drawing of U-profile 05 TU1 1501. Dimensions: top width 6, bottom width 3, height 8, side thickness 3, and top flange height 3.</p>	 <p>Technical drawing of U-profile 05 TU1 1523. Dimensions: top width 2.7, bottom width 9, height 13, and side thickness 9.</p>
 <p>Technical drawing of U-profile 05 TU1 1535. Dimensions: top width 22, bottom width 26, height 17, and side thickness 19.</p>	 <p>Technical drawing of U-profile 05 TU1 1536. Dimensions: top width 5.5, bottom width 11.5, height 20, and side thickness 23.</p>	 <p>Technical drawing of U-profile 05 TU1 1541. Dimensions: top width 9, bottom width 25, height 7, and side thickness 12.</p>
 <p>Technical drawing of U-profile 05 TU1 1565. Dimensions: top width 4.1, bottom width 1.1, height 10, and side thickness 18.</p>	 <p>Technical drawing of U-profile 05 TU1 1572. Dimensions: top width 1.7, bottom width 15.4, height 16.1, and side thickness 12.</p>	 <p>Technical drawing of U-profile 05 TU1 1598. Dimensions: top width 6, bottom width 12, height 11.5, and side thickness 21.</p>
 <p>Technical drawing of U-profile 05 TU1 1599. Dimensions: top width 3, bottom width 7, height 13, and side thickness 15.</p>	 <p>Technical drawing of U-profile 05 TU1 1606. Dimensions: top width 3, bottom width 8.5, height 33, and side thickness 14.</p>	 <p>Technical drawing of U-profile 05 TU1 1611. Dimensions: top width 1.6, bottom width 4.5, height 4, and side thickness 6.</p>

Technische U-Profile

aus Vollgummi bzw. Weich-PVC

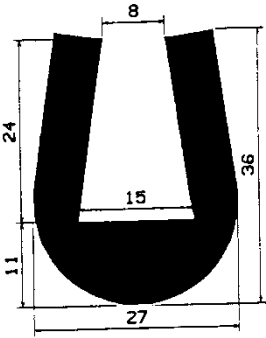
GUK

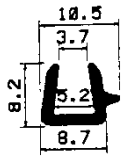
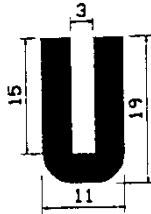
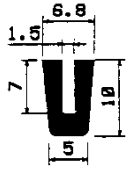
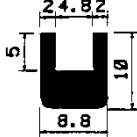
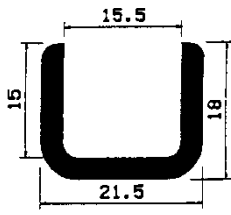
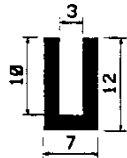
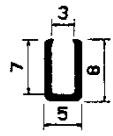
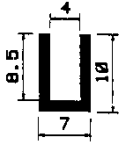
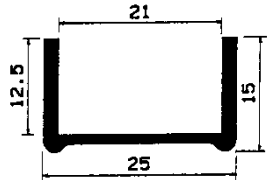
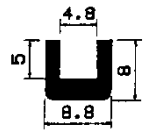
 <p>Technical drawing of U-profile 05 TU1 1617. Dimensions: top width 8, height from top to bottom curve 24, bottom curve depth 11, bottom width 27, inner width 15, and total height 36.</p>	 <p>Technical drawing of U-profile 05 TU1 1618. Dimensions: top width 1.2, height from top to bottom curve 7, bottom curve depth 4, bottom width 10, and total height 10.</p>	 <p>Technical drawing of U-profile 05 TU1 1619. Dimensions: top width 10.5, height from top to bottom curve 3.7, bottom curve depth 8.2, bottom width 8.7, and inner width 5.2.</p>
 <p>Technical drawing of U-profile 05 TU1 1633. Dimensions: top width 3, height from top to bottom curve 15, bottom curve depth 11, and total height 19.</p>	 <p>Technical drawing of U-profile 05 TU1 1636. Dimensions: top width 6.8, height from top to bottom curve 1.5, bottom curve depth 7, bottom width 5, and total height 10.</p>	 <p>Technical drawing of U-profile 05 TU1 1654. Dimensions: top width 24.82, height from top to bottom curve 5, bottom curve depth 8.8, and total height 10.</p>
 <p>Technical drawing of U-profile 05 TU1 1657. Dimensions: top width 15.5, height from top to bottom curve 15, bottom curve depth 21.5, and total height 18.</p>	 <p>Technical drawing of U-profile 05 TU1 1669. Dimensions: top width 3, height from top to bottom curve 10, bottom curve depth 7, and total height 12.</p>	 <p>Technical drawing of U-profile 05 TU1 1687. Dimensions: top width 3, height from top to bottom curve 7, bottom curve depth 5, and total height 8.</p>
 <p>Technical drawing of U-profile 05 TU1 1688. Dimensions: top width 4, height from top to bottom curve 8.5, bottom curve depth 7, and total height 10.</p>	 <p>Technical drawing of U-profile 05 TU1 1696. Dimensions: top width 21, height from top to bottom curve 12.5, bottom curve depth 25, and total height 15.</p>	 <p>Technical drawing of U-profile 05 TU1 1709. Dimensions: top width 4.8, height from top to bottom curve 5, bottom curve depth 8.8, and total height 8.</p>